

テープ図で かんがえる ひきざん (3つのかず・くりさがりなし)
あいている□の中に、のこりのかずを書きましょう

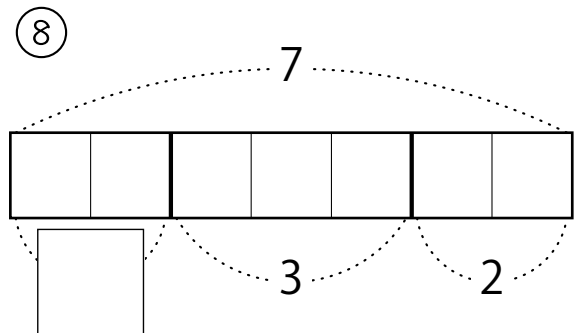

テープ図で かんがえる ひきざん (3つのかず・くりさがりなし)
あいている□の中に、のこりのかずを書きましょう

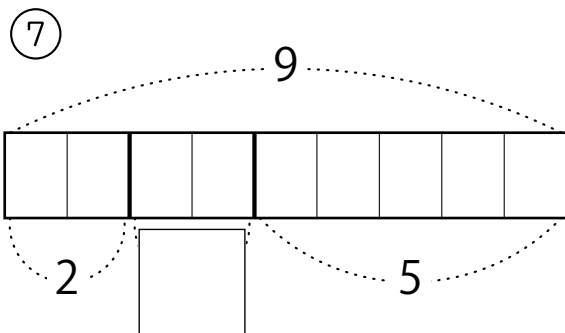
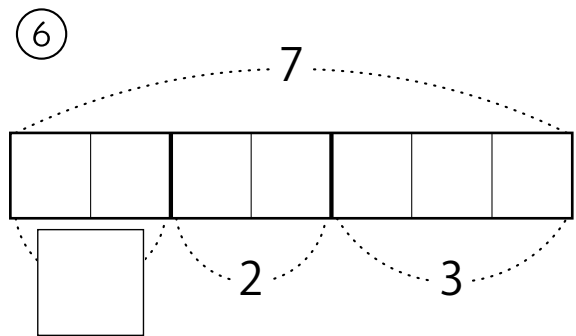
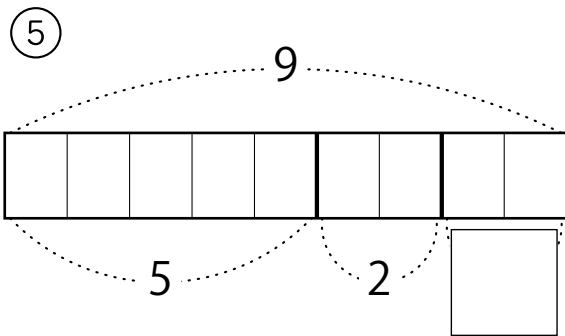
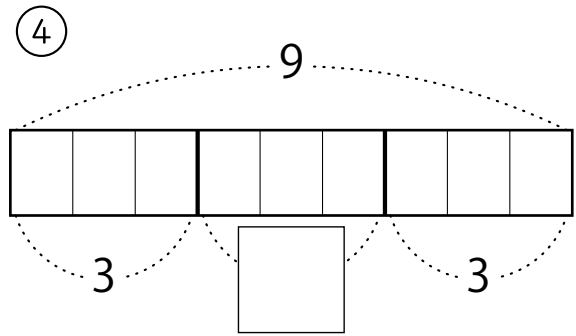
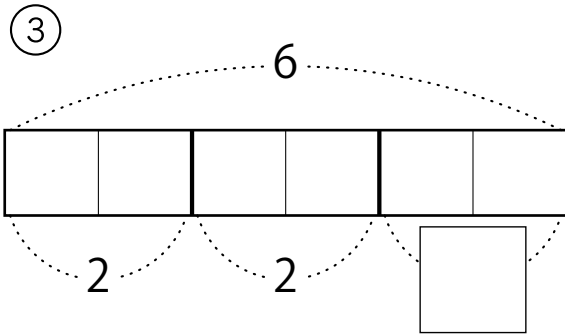
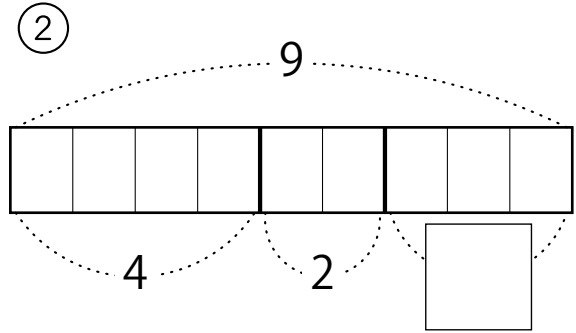
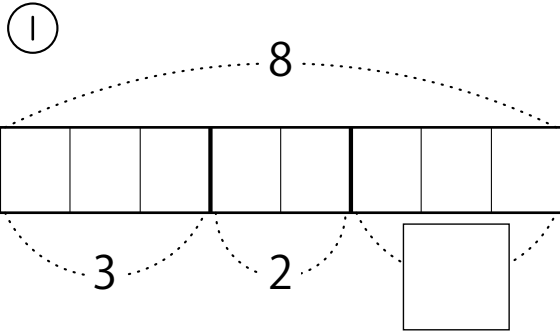
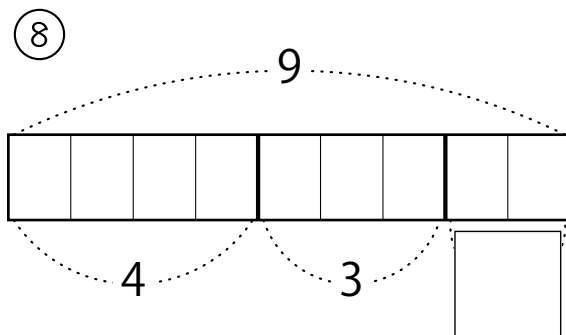
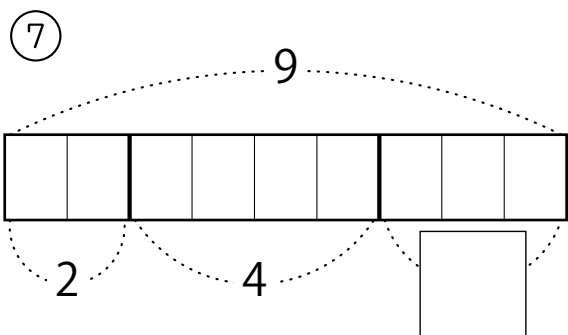
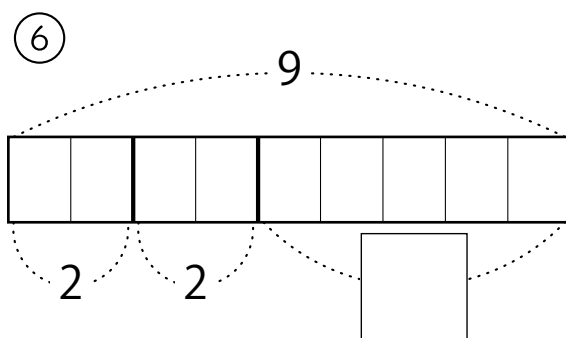
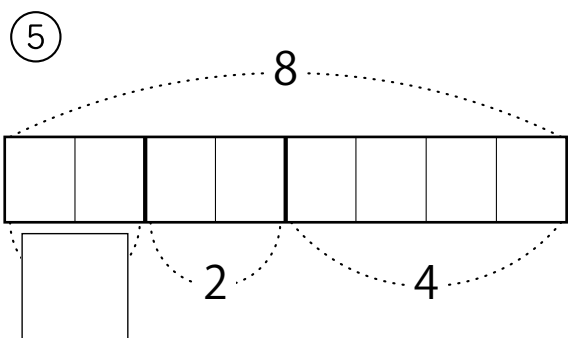
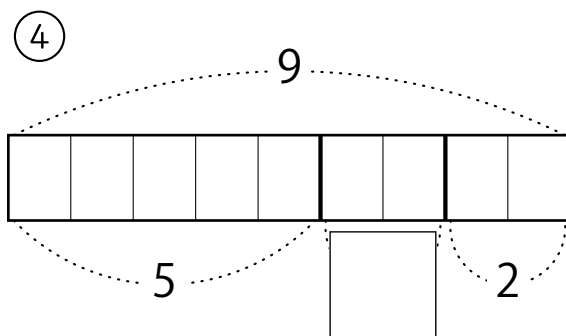
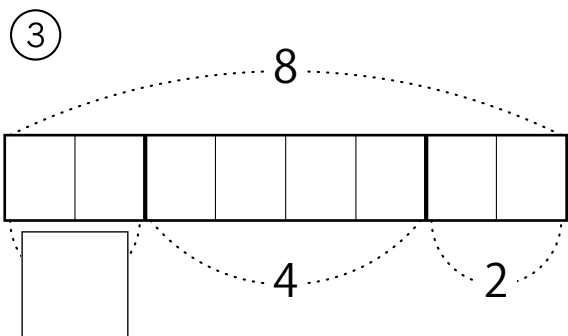
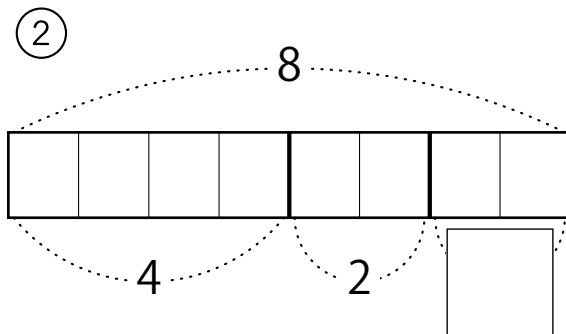
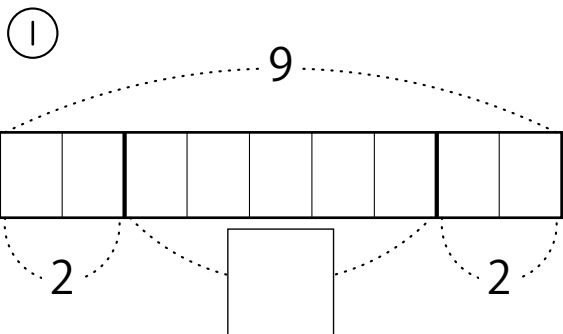

テープ図
た げん
引き算

テープ図で かんがえる ひきざん (3つのかず・くりさがりなし)
あいている □ のなか、のこりのかずを書きましょう

