

テープ図で かんがえる ひきざん (10まで)

あいている□の中に、のこりのかずを書きましょう

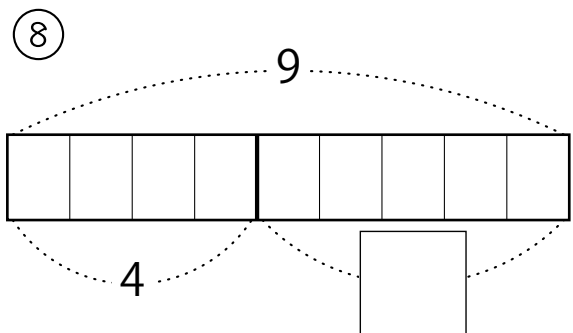

テープ図で かんがえる ひきざん (10まで)
あいている□の中に、のこりのかずを書きましょう

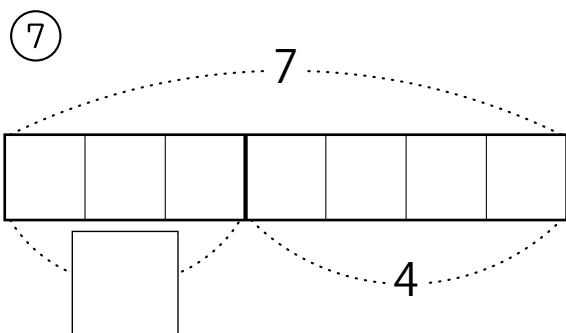
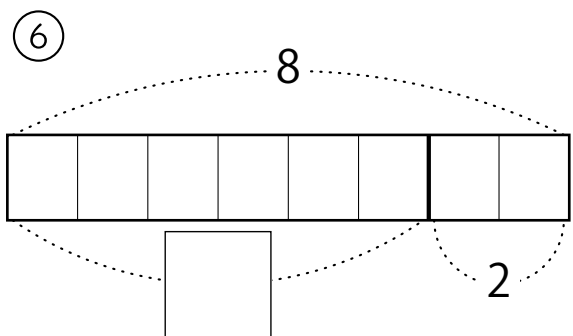
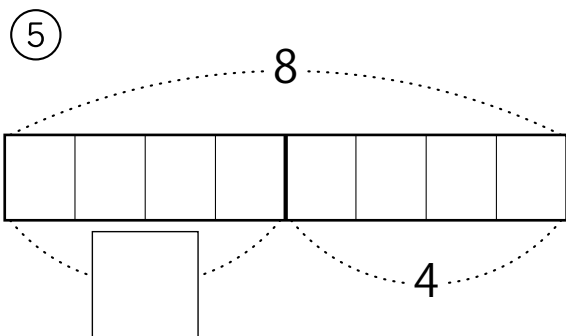
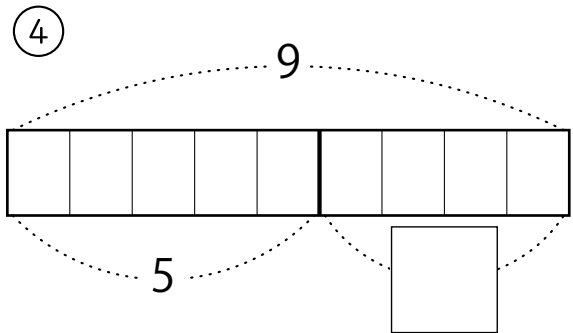
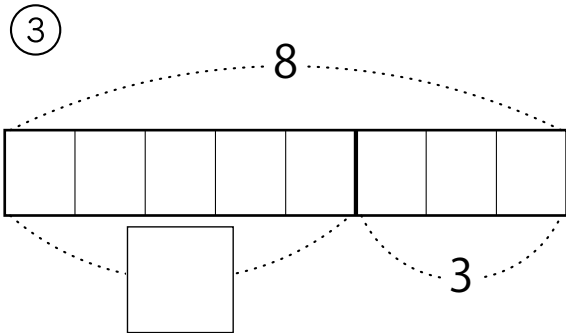
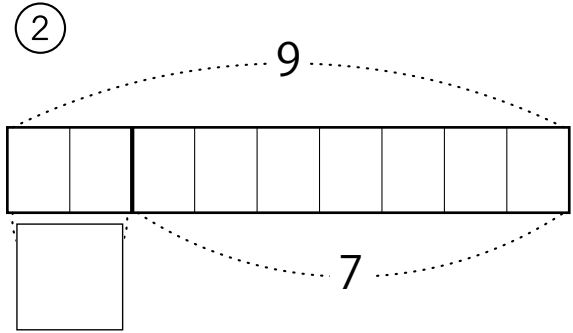
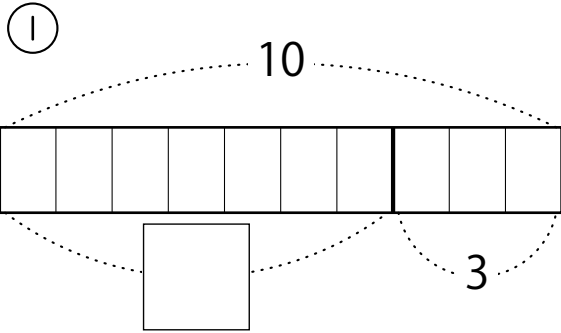
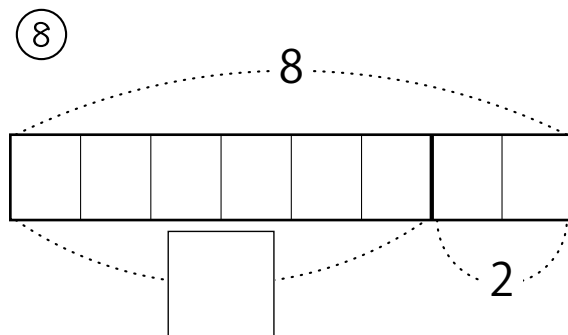
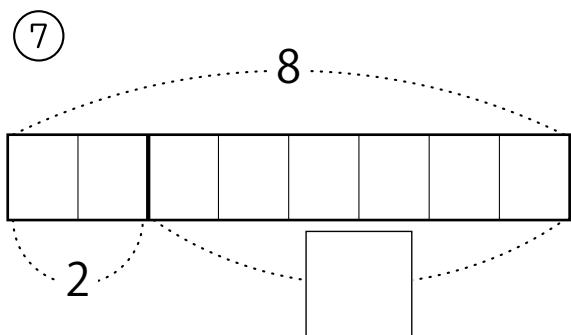
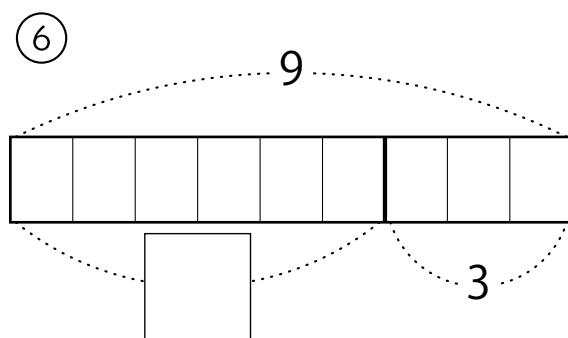
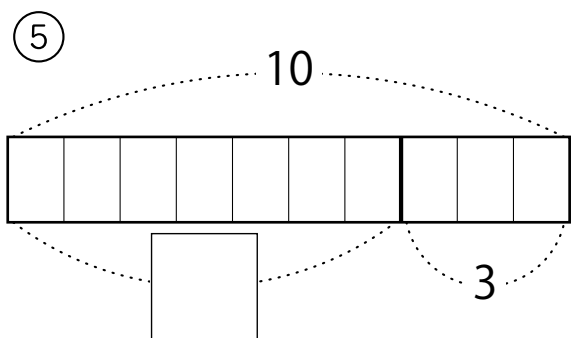
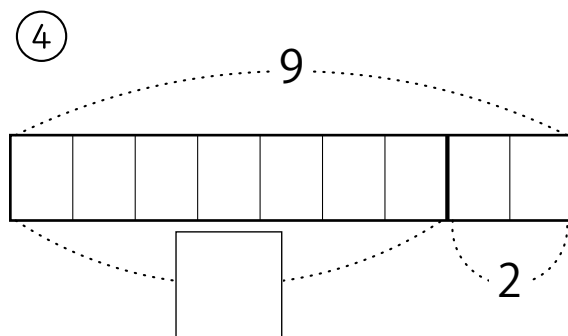
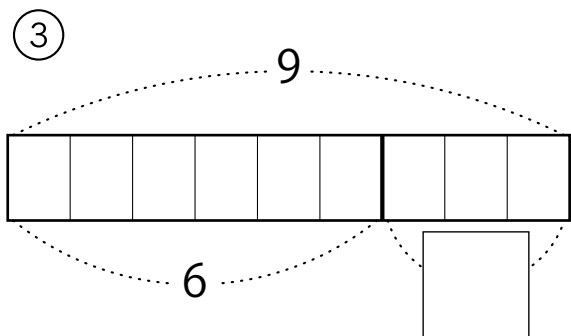
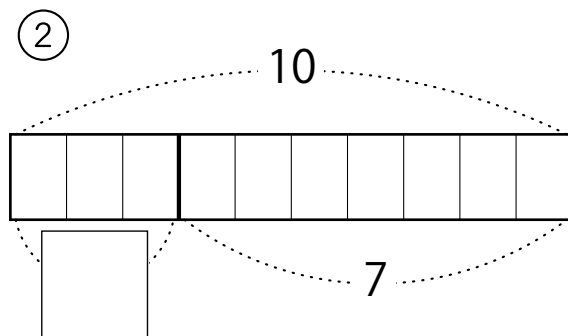
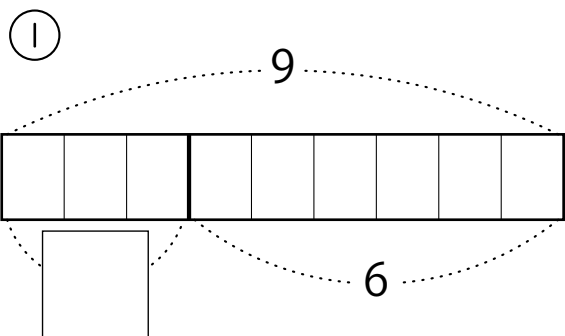

テープ図で かんがえる ひきざん (10まで)
あいている□の中に、のこりのかずを書きましょう

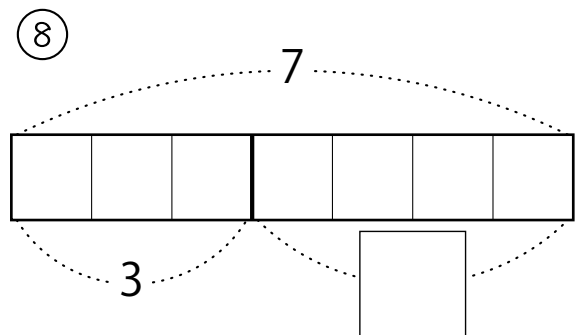
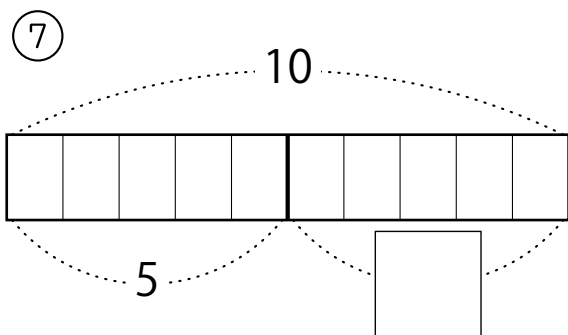
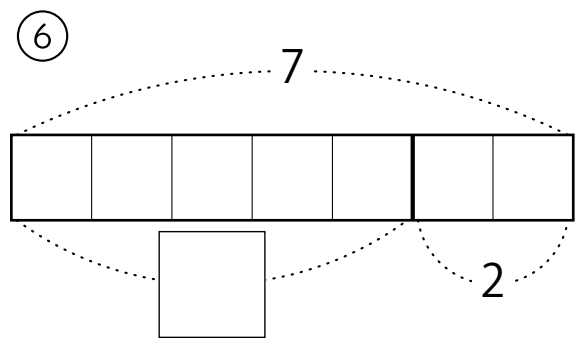
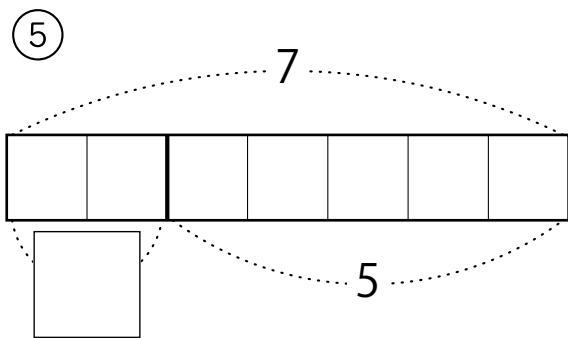
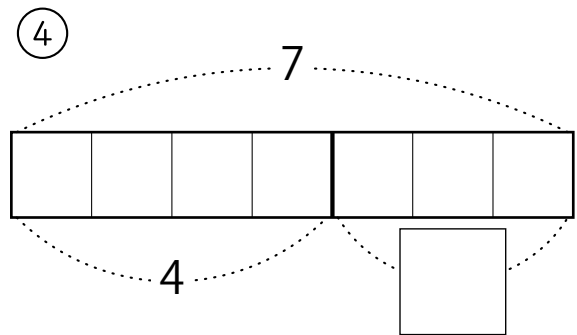
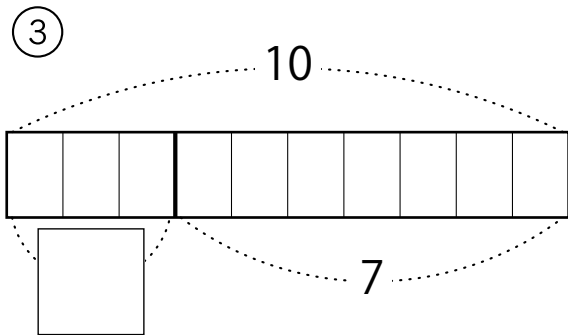
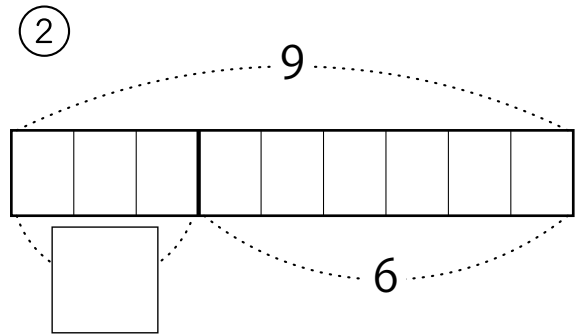
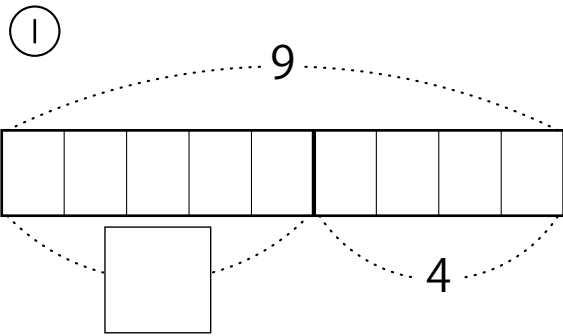

テープ図で かんがえる ひきざん (10まで)
あいている□の中に、のこりのかずを書きましょう

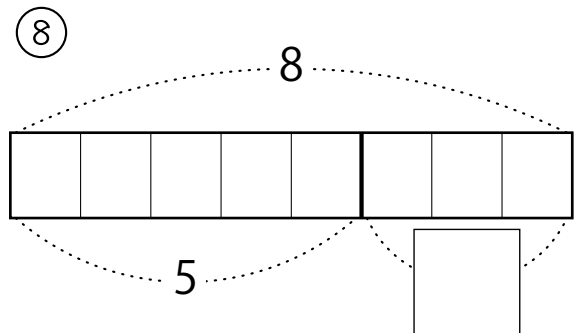
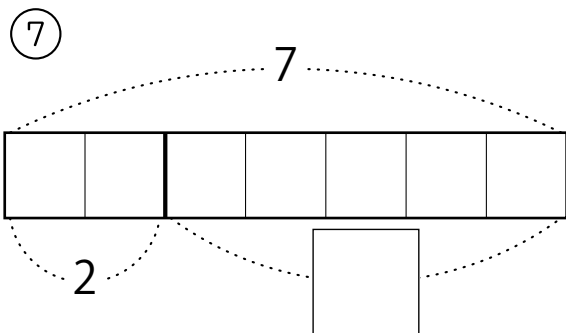
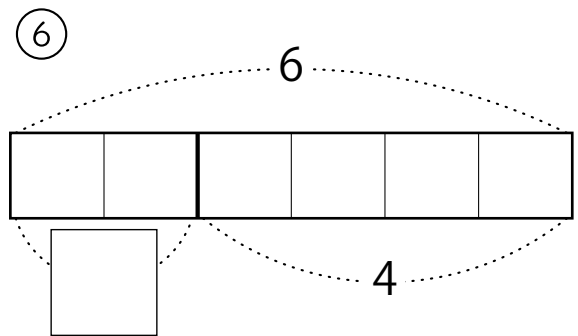
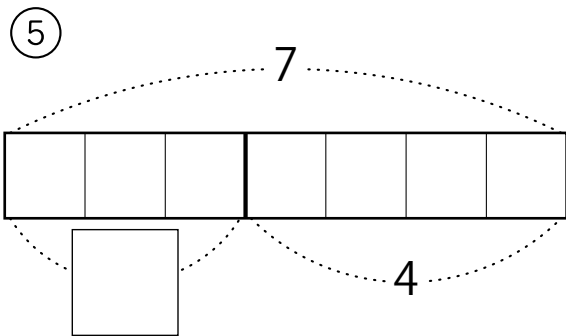
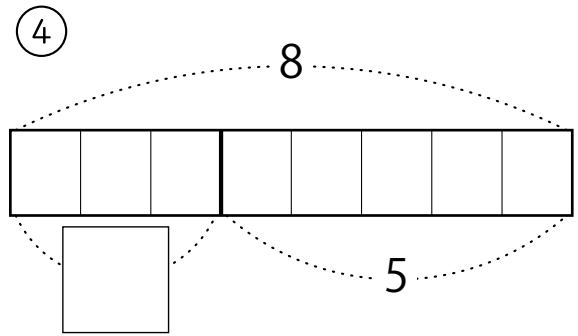
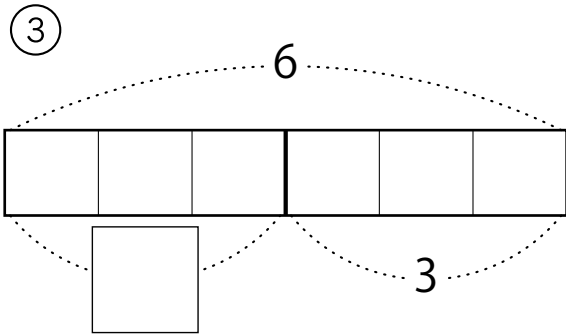
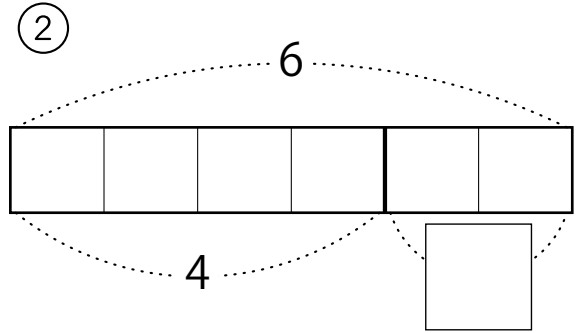
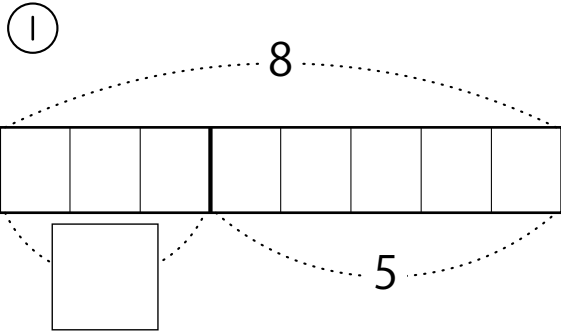

テープ図で かんがえる ひきざん (10まで)
あいている□の中に、のこりのかずを書きましょう

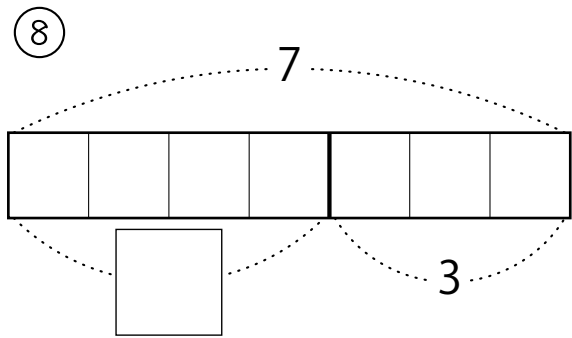
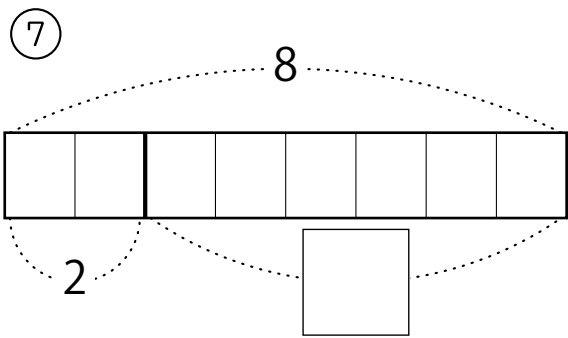
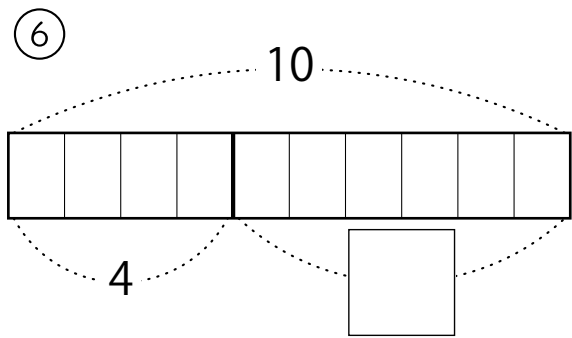
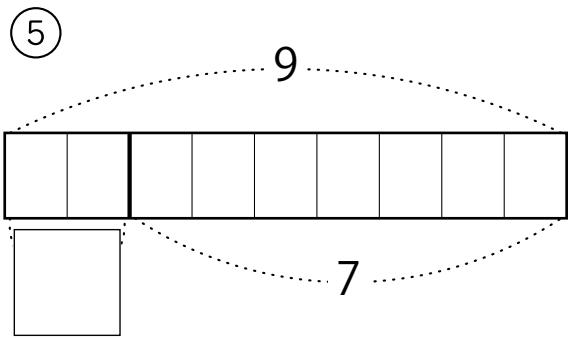
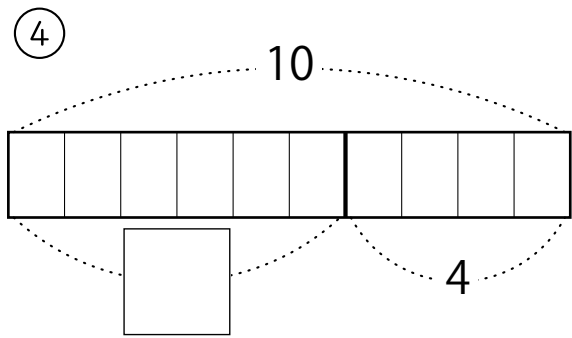
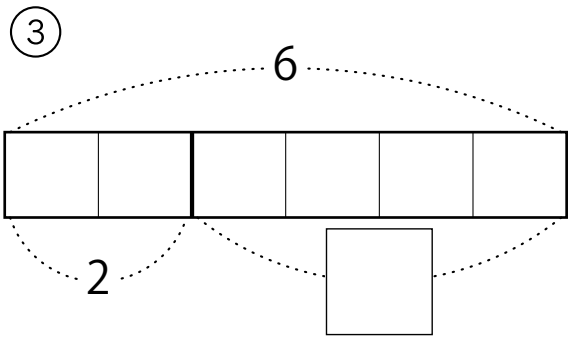
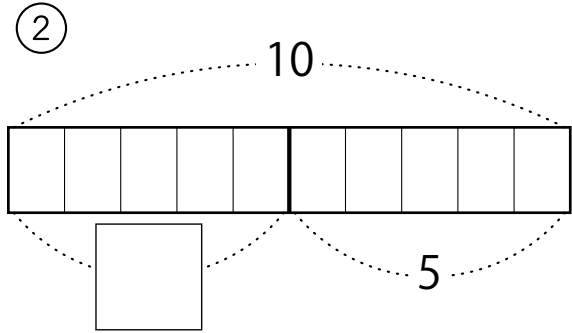
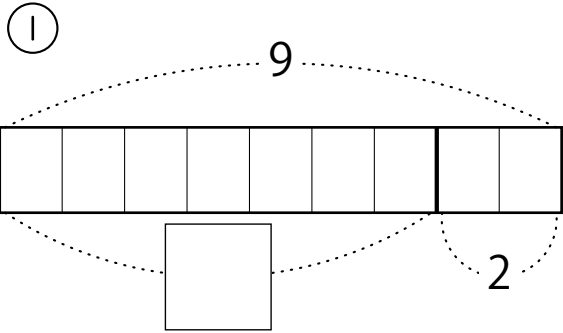

テープ図で かんがえる ひきざん (10まで)
あいている□の中に、のこりのかずを書きましょう

