

テープ図
まとめ ①

□に入る ^{はい} かずは いくつ？ (10までの たしざん・ひきざん)

たしざん？ ひきざん？ あいている □の ^{なか} ^{はい} 中に入る ^か かずを書こう

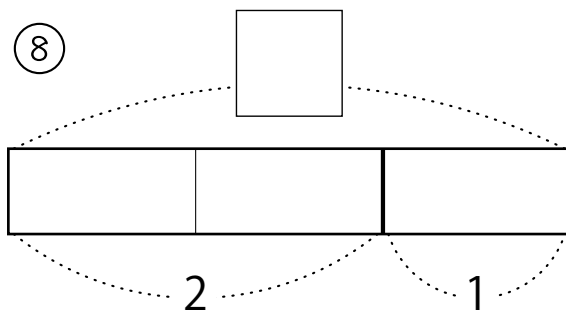
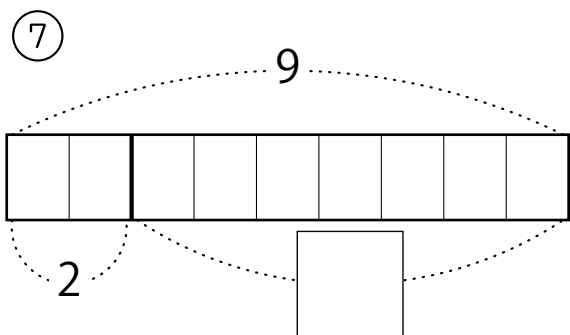
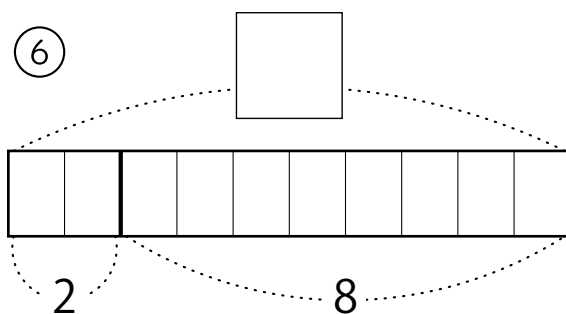
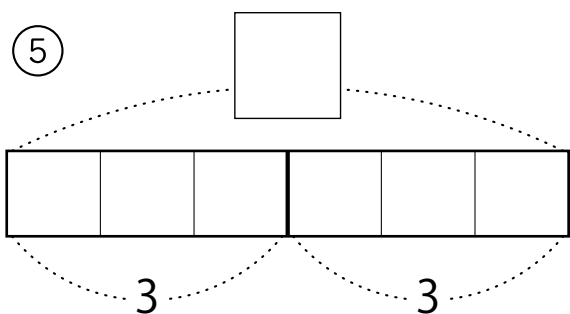
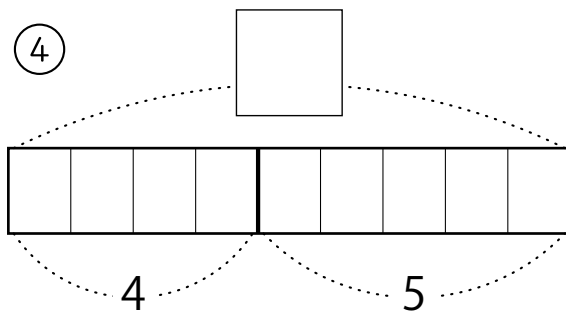
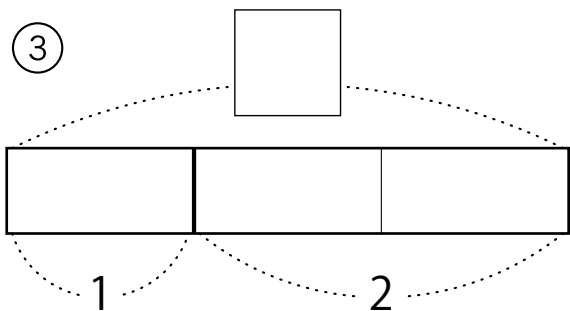
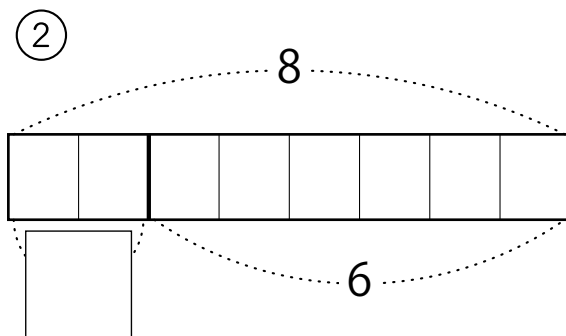
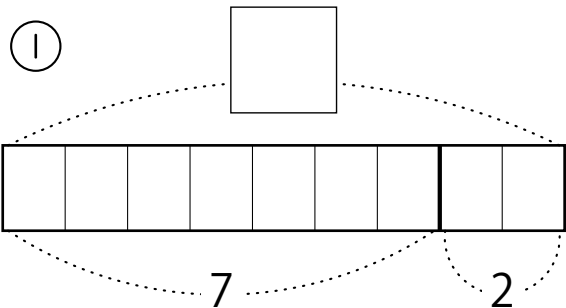

テープ図
まとめ ①

□に入る ^{はい} かずは いくつ？ (10までの たしざん・ひきざん)

たしざん？ひきざん？ あいている □の ^{なか} ^{はい} 中に入る ^か かずを書こう

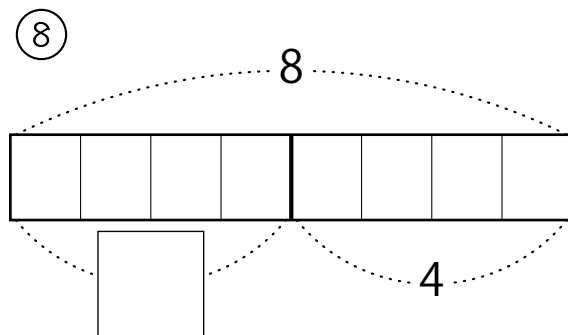
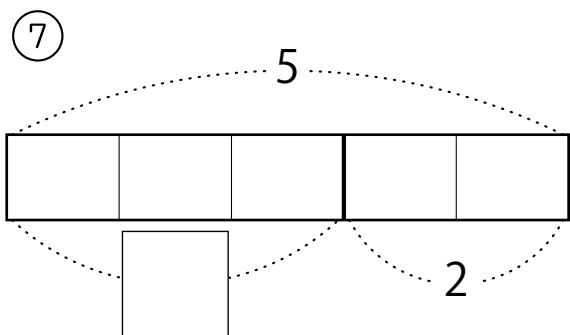
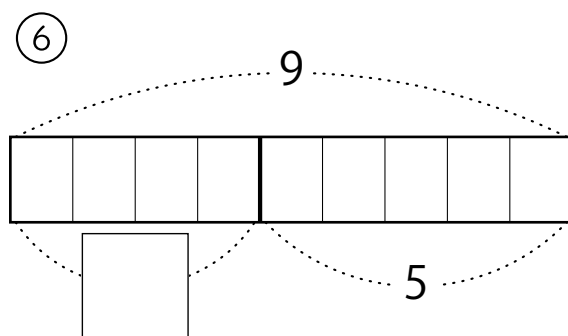
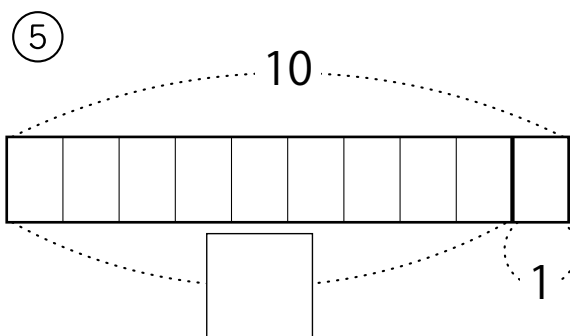
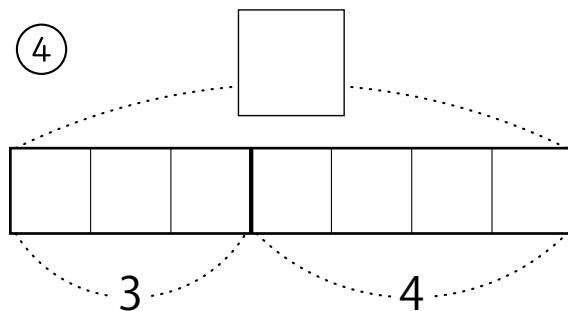
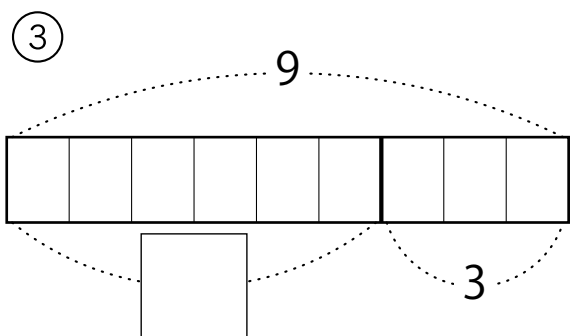
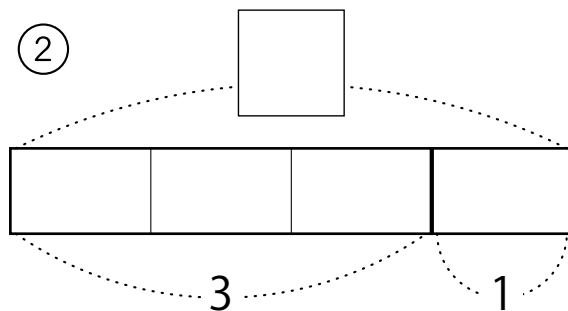
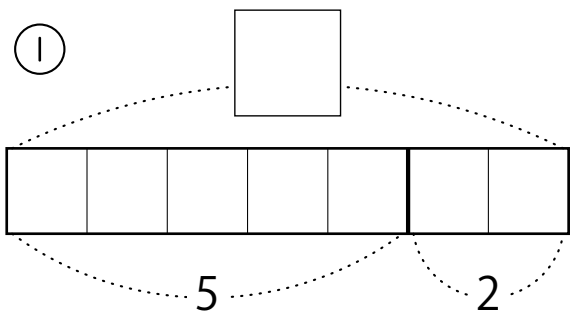

テープ図
まとめ ①

□に入る ^{はい}かずは いくつ？ (10までの たしざん・ひきざん)

たしざん？ひきざん？ あいている □の ^{なか} ^{はい}中に入る ^かかずを書こう

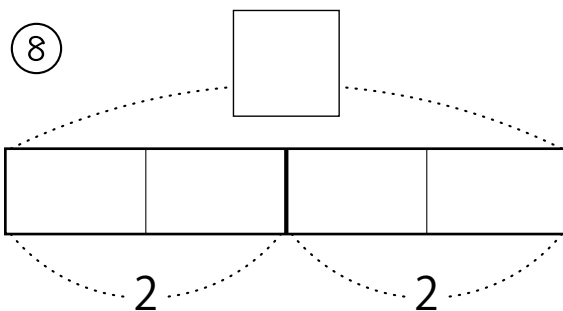
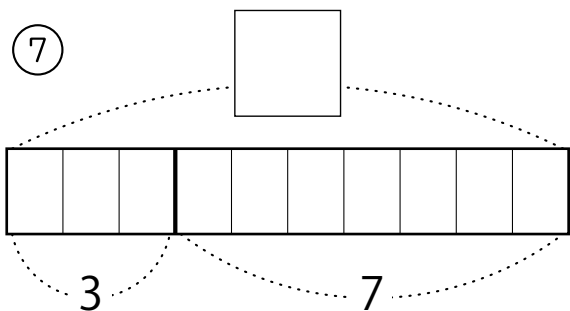
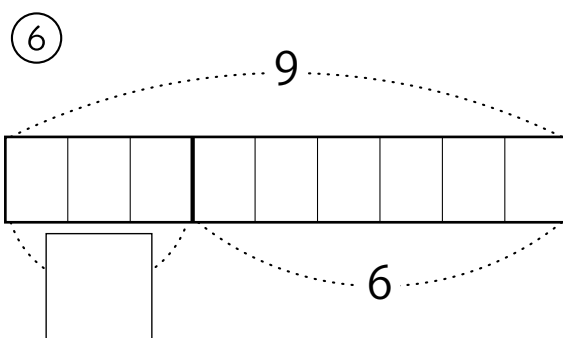
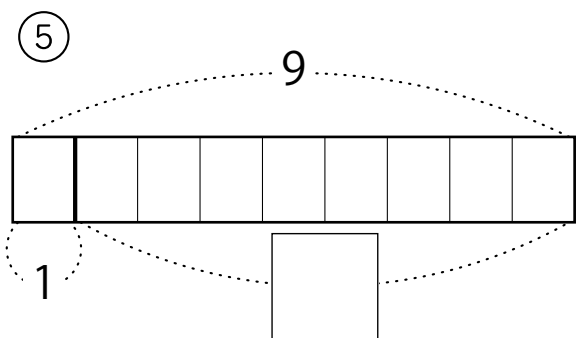
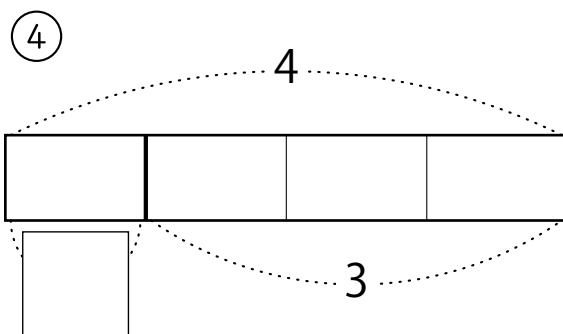
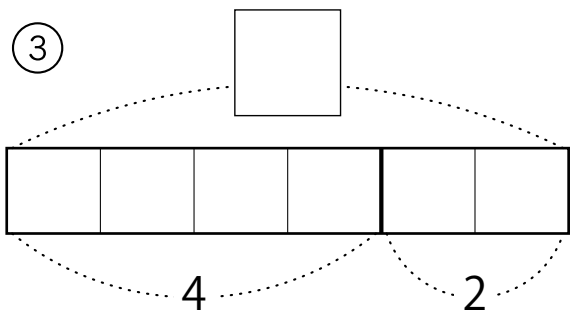
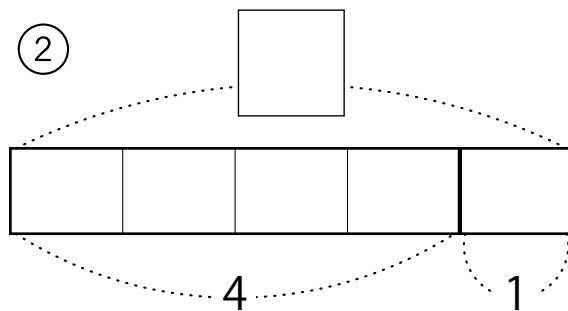
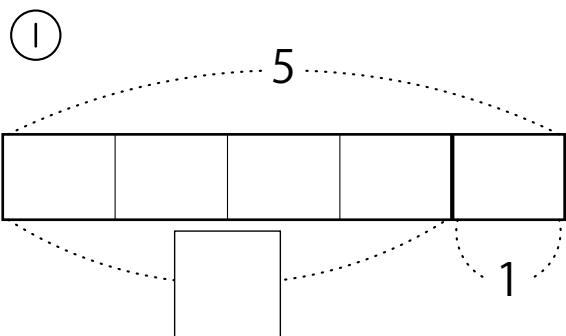

テープ図
まとめ ①

□に入る ^{はい} かずは いくつ？ (10までの たしざん・ひきざん)
たしざん？ひきざん？ あいている □ ^{なか} ^{はい} の中に入るかずを書こう

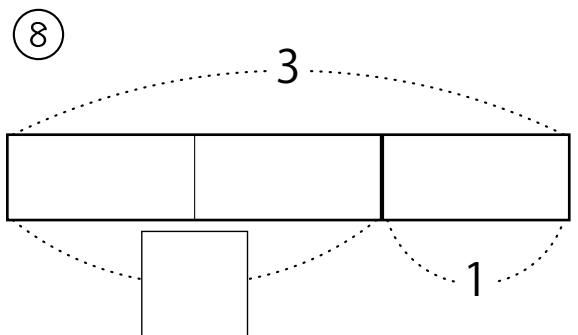
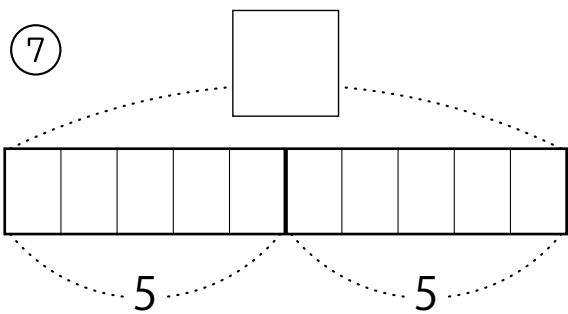
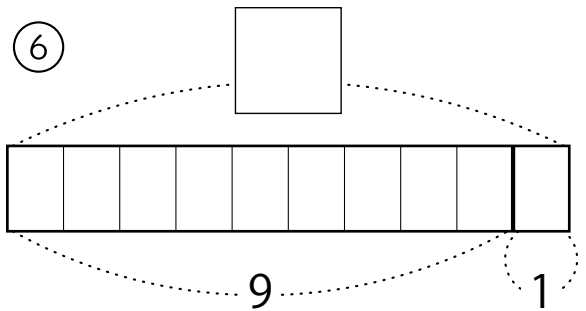
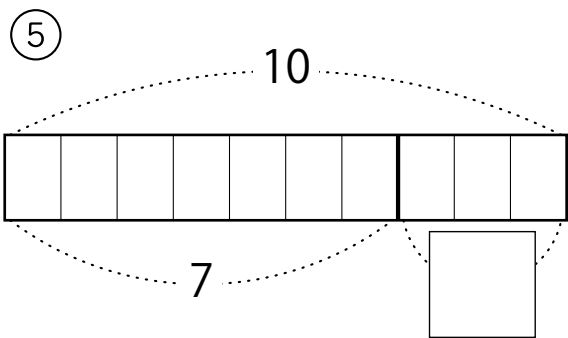
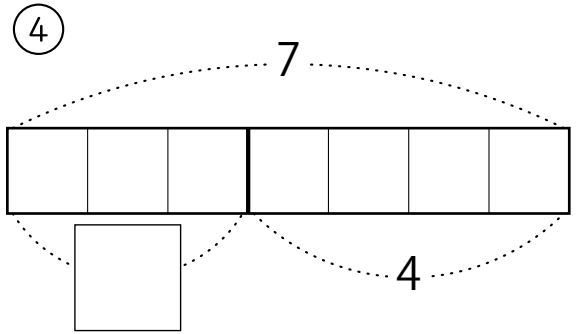
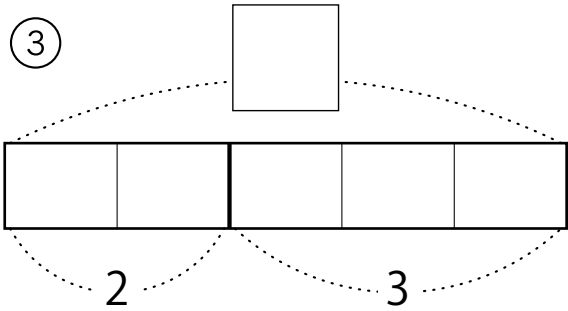
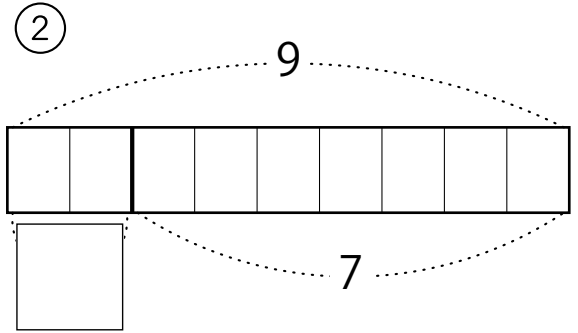
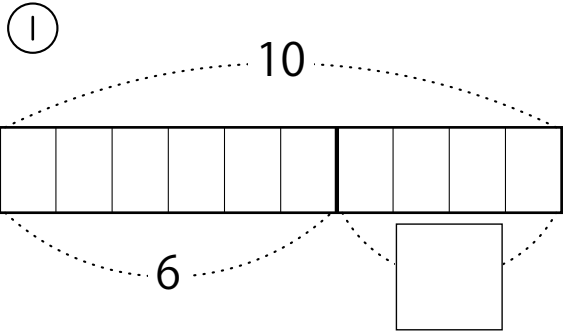

テープ図
まとめ ①

□に入る ^{はい}かずは いくつ？ (10までの たしざん・ひきざん)

たしざん？ひきざん？ あいている □の ^{なか} ^{はい}中に入る ^かかずを書こう

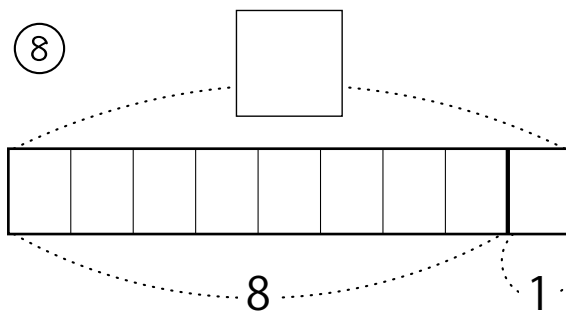
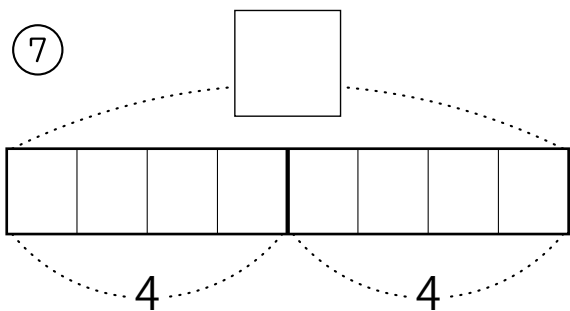
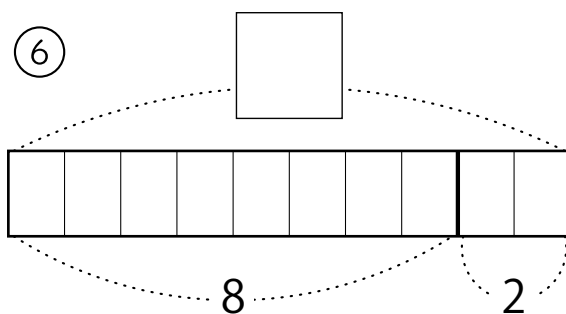
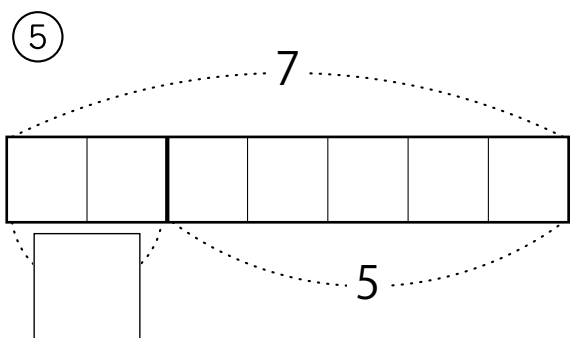
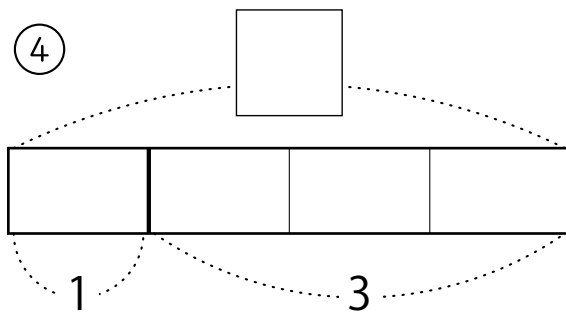
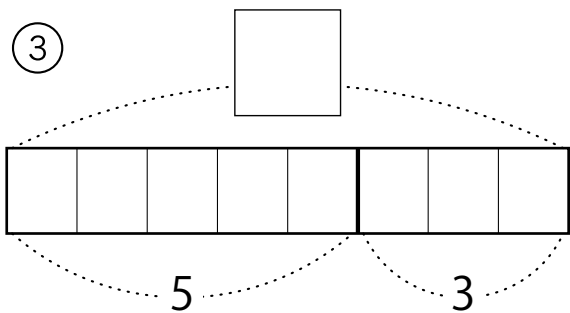
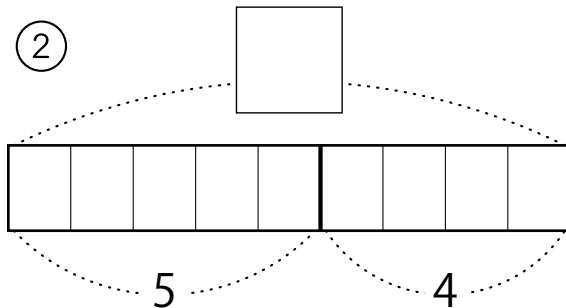
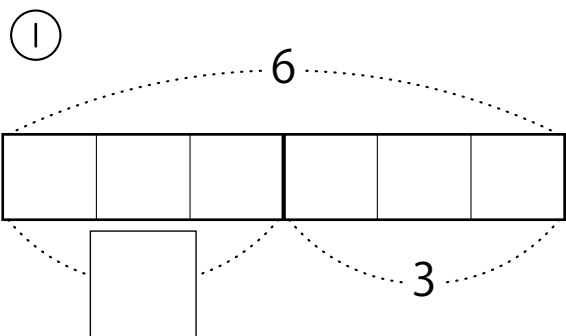

テープ図
まとめ ①

□に入る ^{はい}かずは いくつ？ (10までの たしざん・ひきざん)

たしざん？ひきざん？ あいている □の ^{なか} ^{はい}中に入る ^かかずを書こう

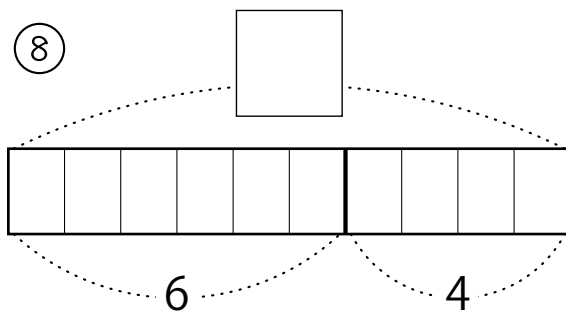
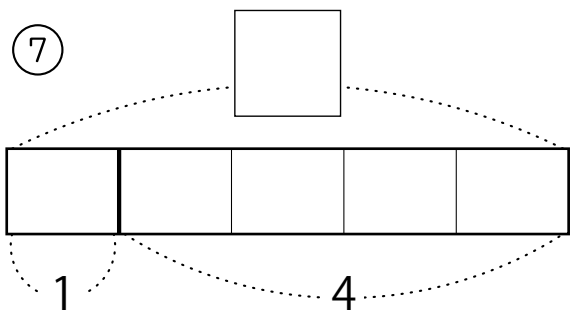
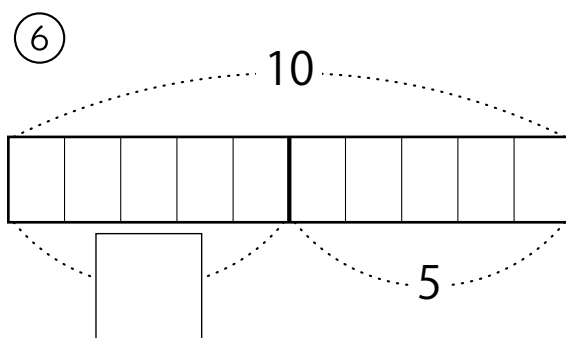
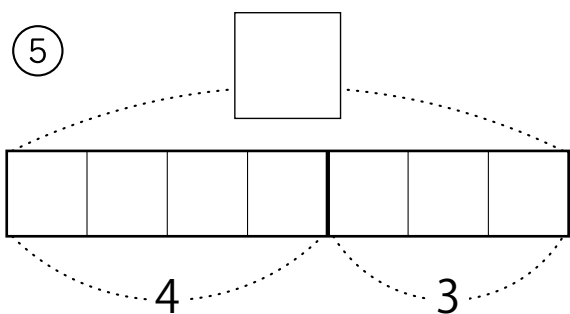
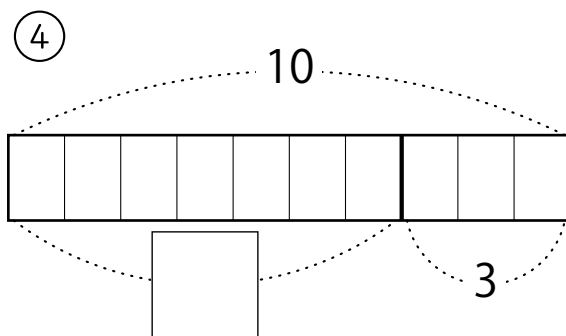
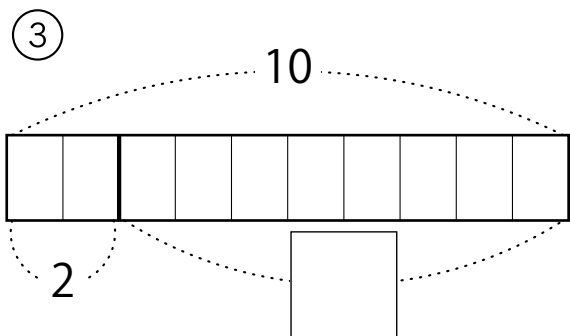
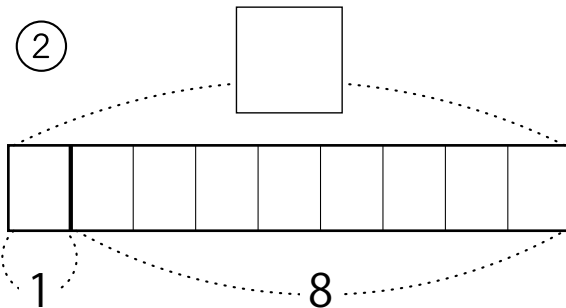
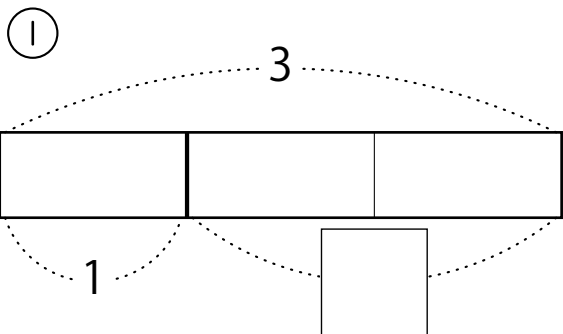

テープ図
まとめ ①

□に入るか^{はい}ずはいくつ？ (10までのたしざん・ひきざん)
たしざん？ひきざん？ あいている□の中^{なか}に入^{はい}るか^かずを書こう

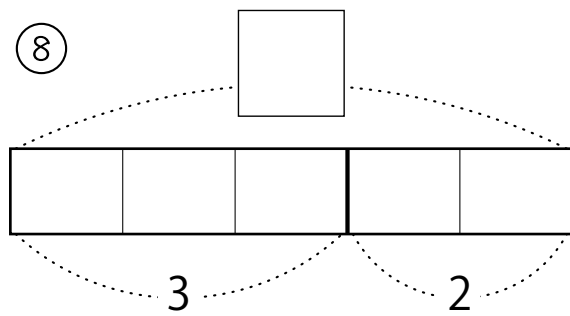
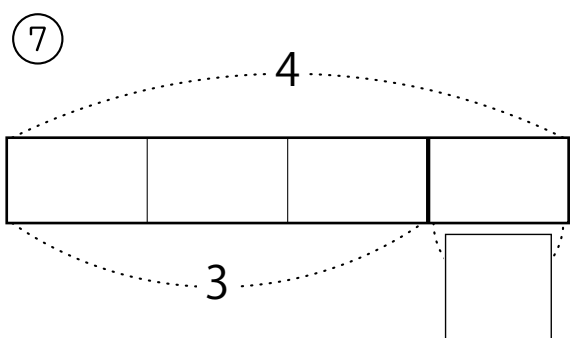
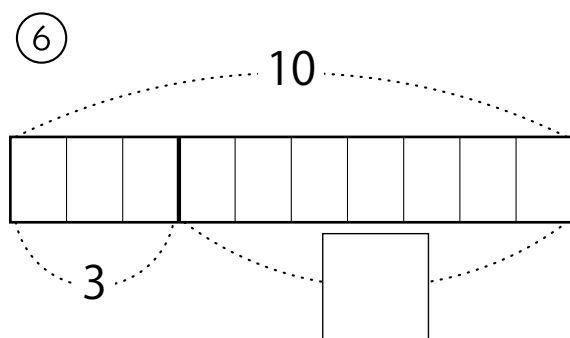
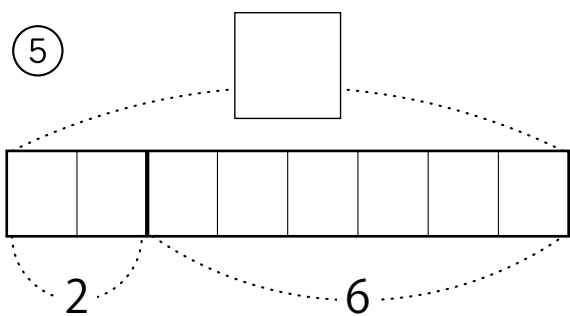
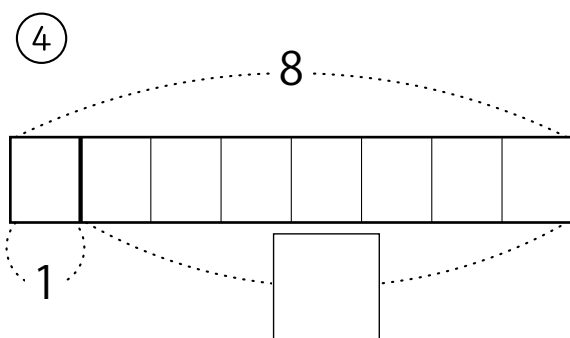
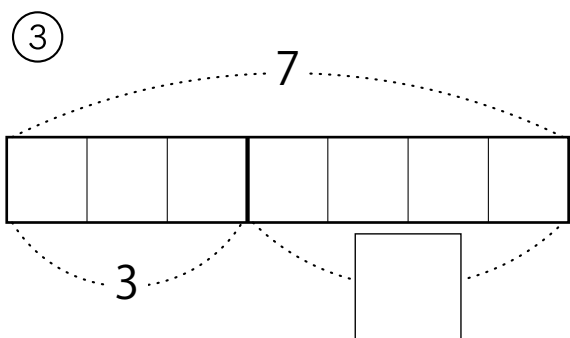
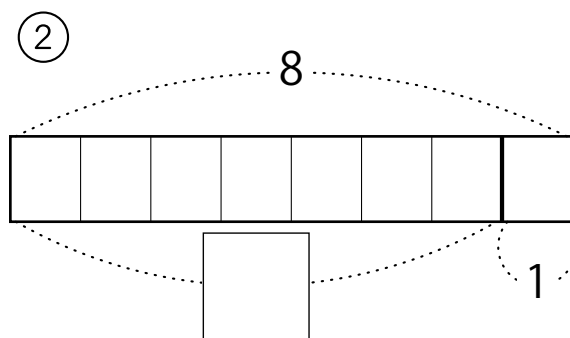
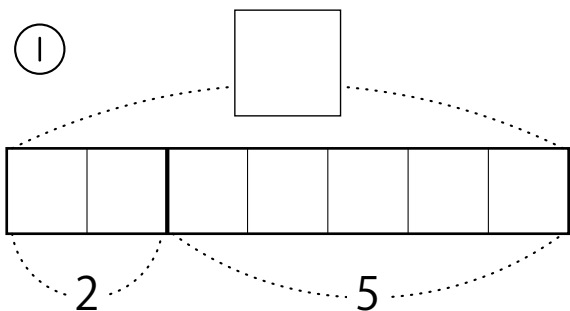

テープ図
まとめ ①

□に入る ^{はい}かずは いくつ？ (10までの たしざん・ひきざん)

たしざん？ ひきざん？ あいている □の ^{なか} ^{はい} ^か 中に入るか ^か ずを書こう

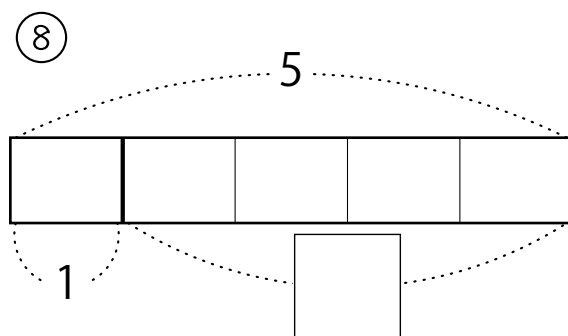
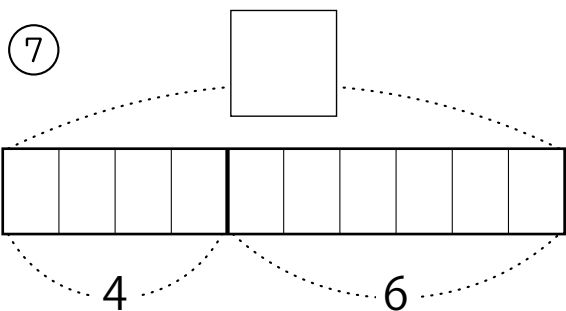
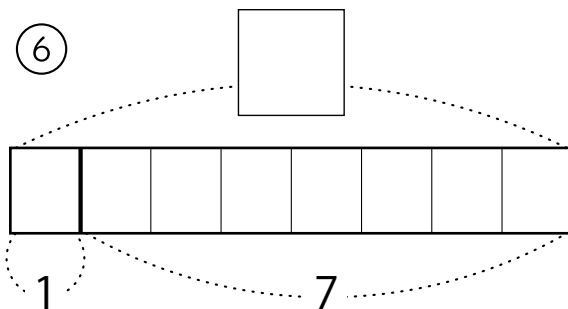
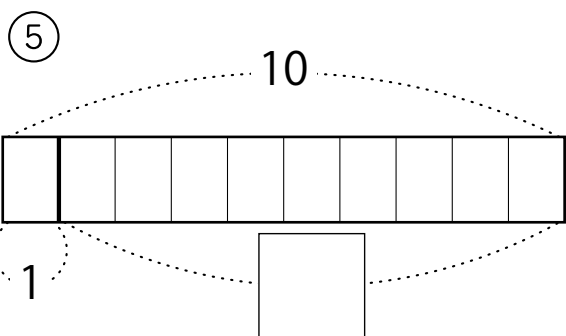
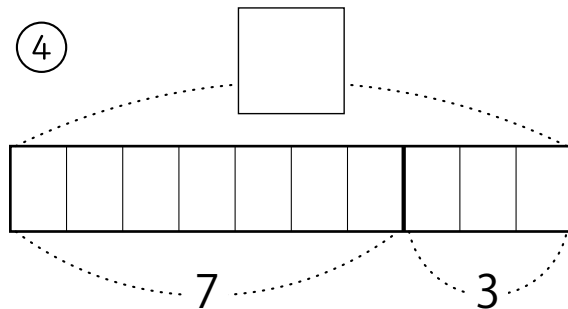
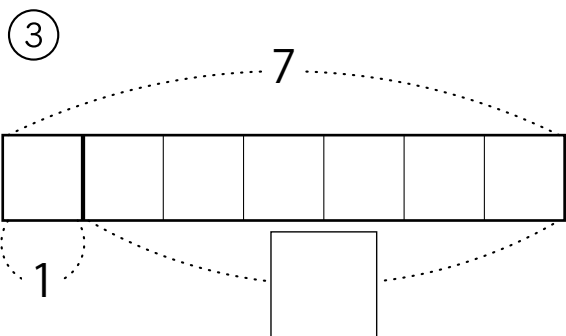
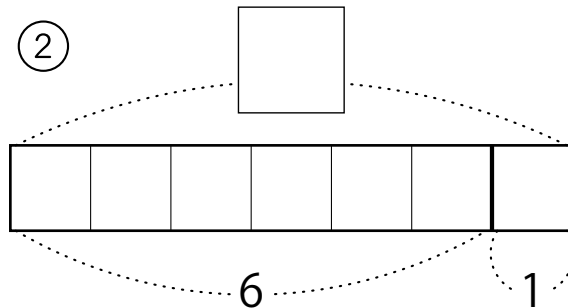
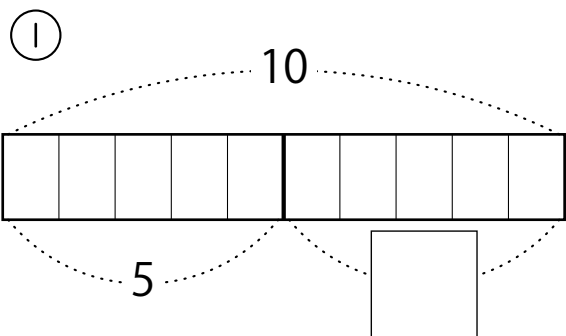

テープ図
まとめ ①

□に入る ^{はい}かずはいくつ？ (10までのたしざん・ひきざん)

たしざん？ひきざん？ あいている□の^{なか}中^{はい}に入^かるかずを書こう

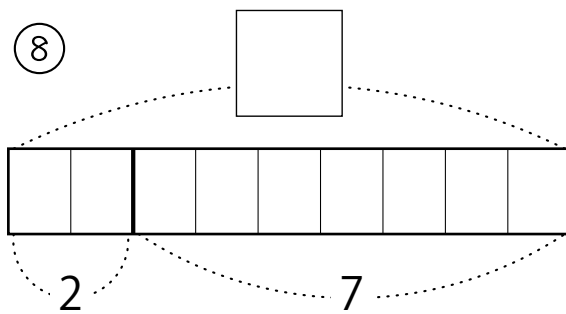
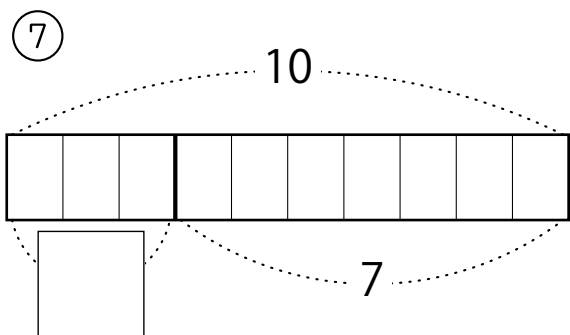
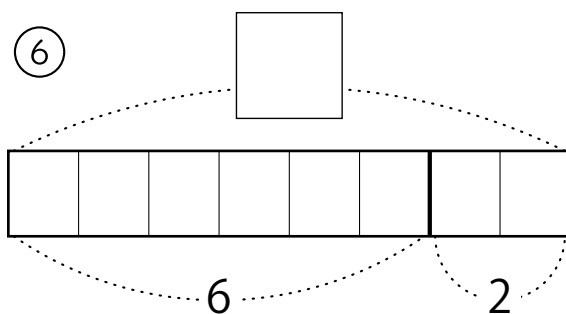
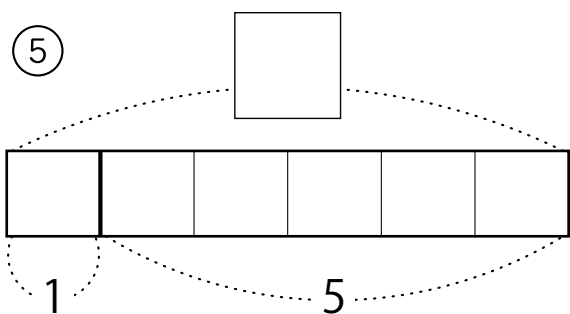
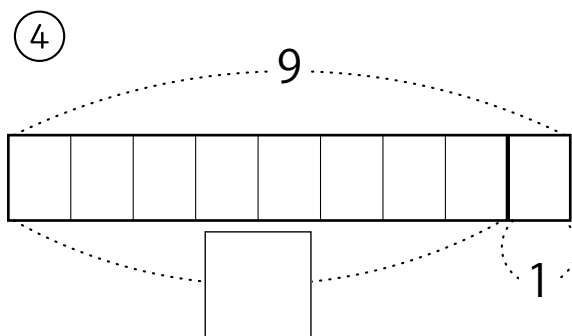
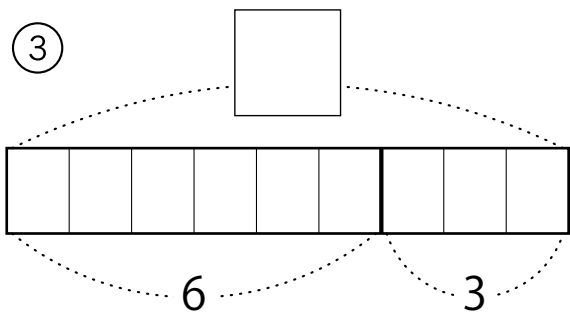
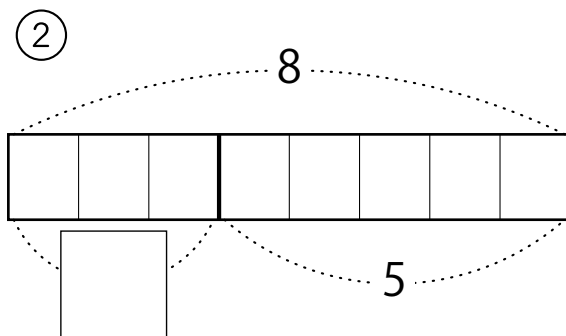
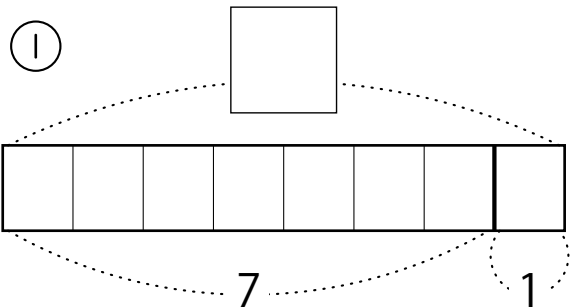

テープ図
まとめ ①

□に入る ^{はい}かずは いくつ？ (10までの たしざん・ひきざん)

たしざん？ひきざん？ あいている □の ^{なか} ^{はい} ^か 中に入るか ^か ずを書こう

