

テープ図で かんがえる たしざん (15から20まで)
あいている の中に 2つのかずをあわせたかずを書こう

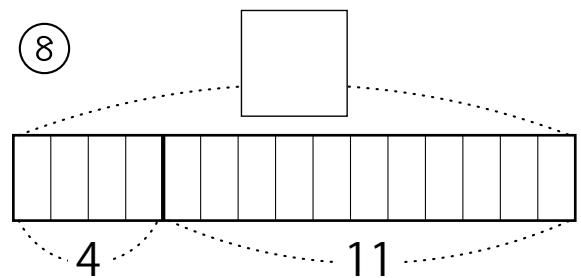

テープ図で かんがえる たしざん (15から20まで)
あいている □ の中に 2つのかずをあわせたかずを書こう

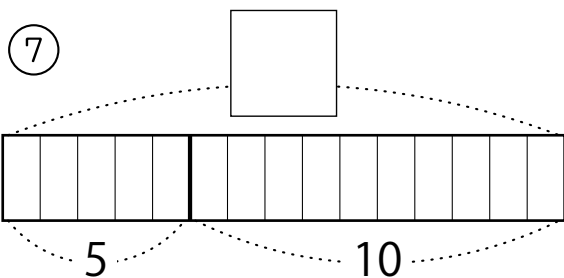
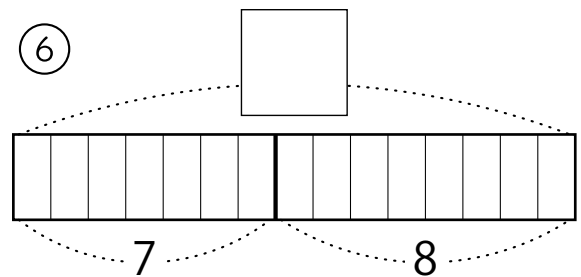
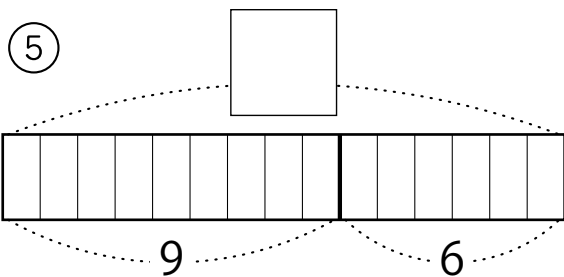
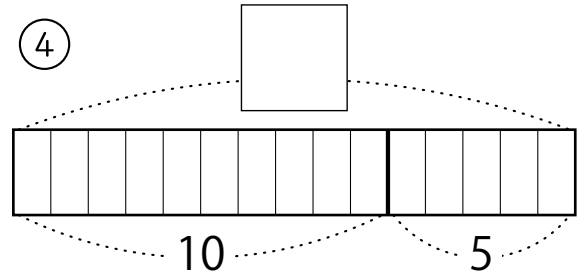
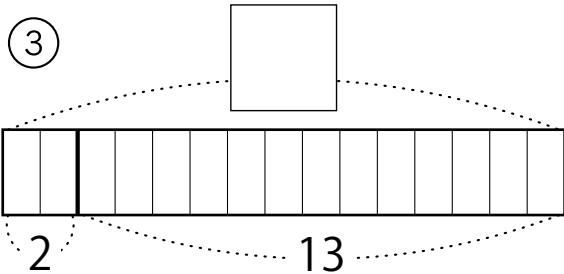
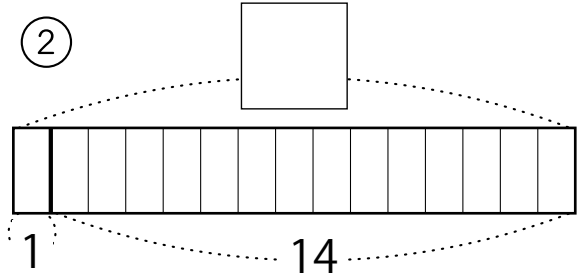
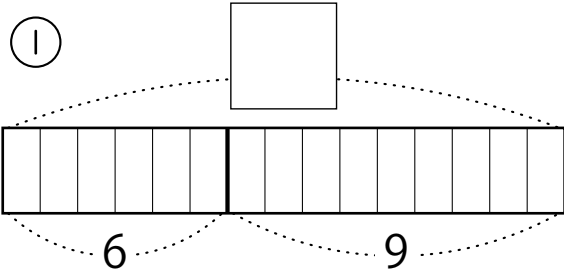
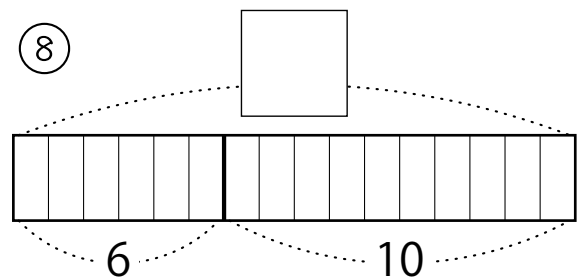
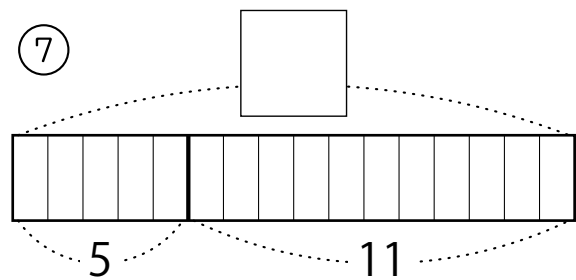
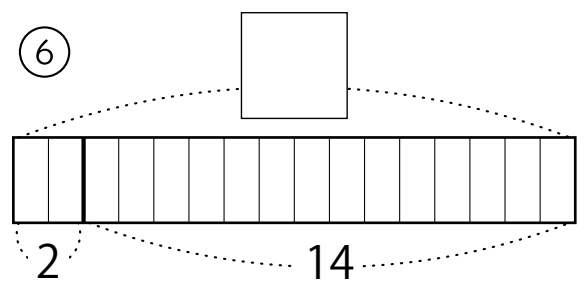
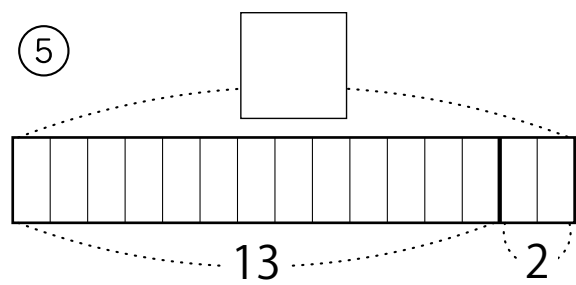
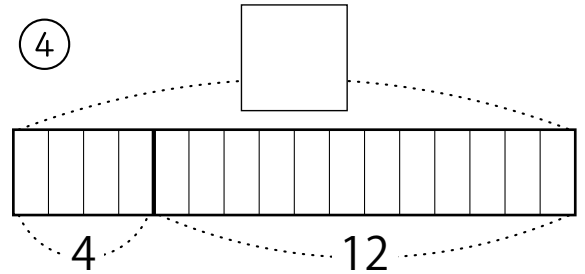
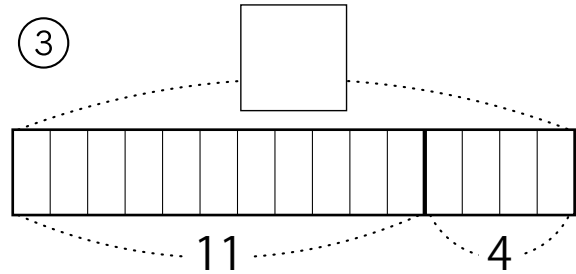
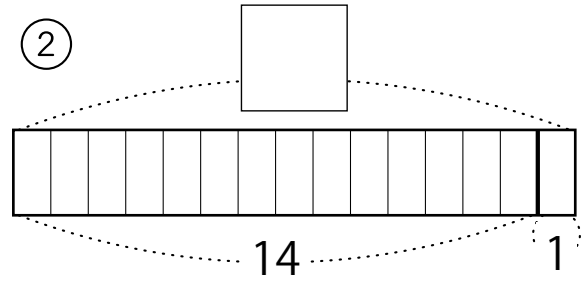
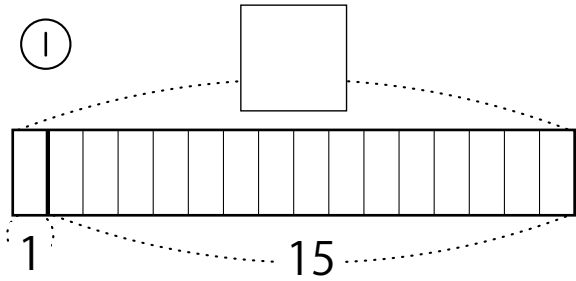

テープ図で かんがえる たしざん (15から20まで)
あいている □ の中に 2つのかずをあわせたかずを書こう

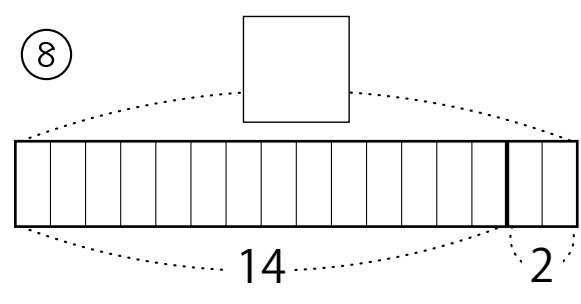
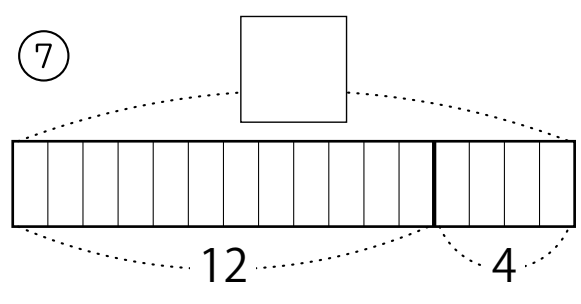
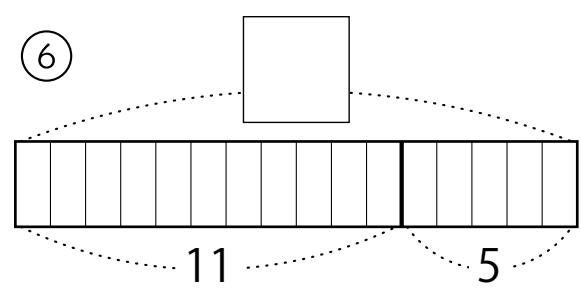
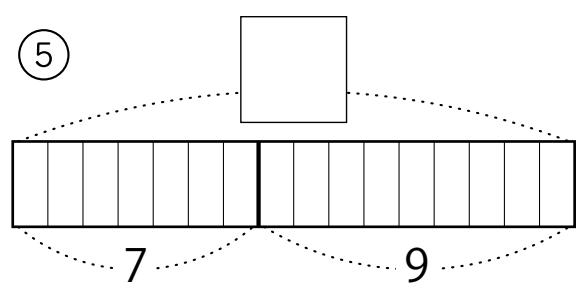
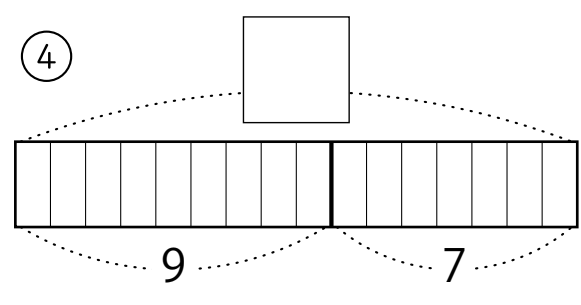
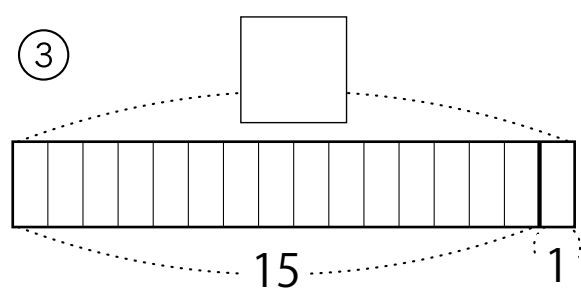
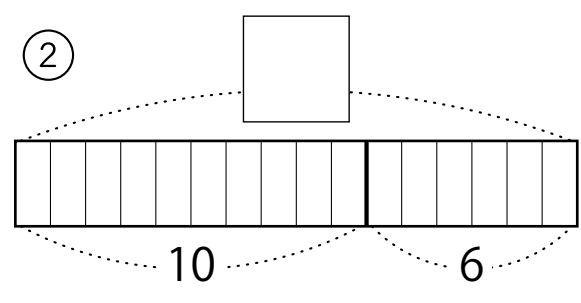
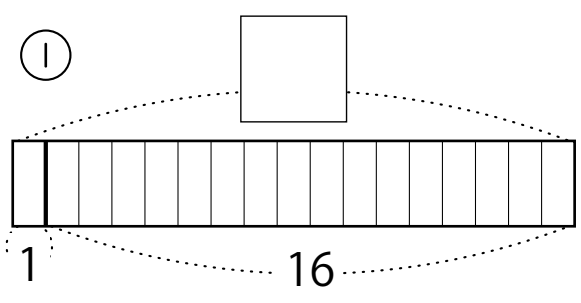

テープ図
たし算
足し算

テープ図で かんがえる たしざん (15から20まで)
あいている の中に 2つのかずをあわせたかずを書こう

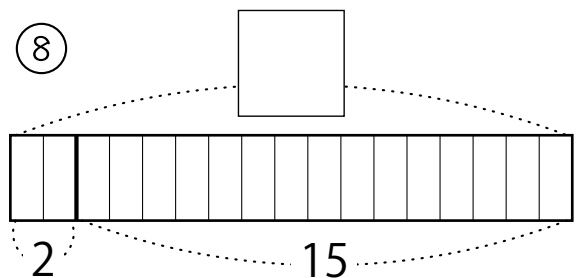
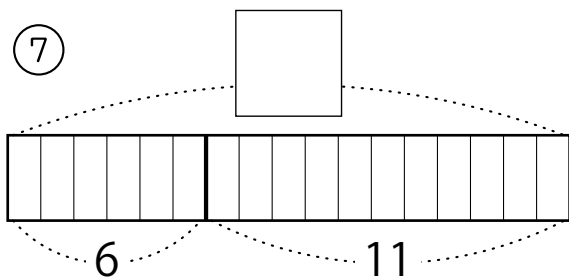
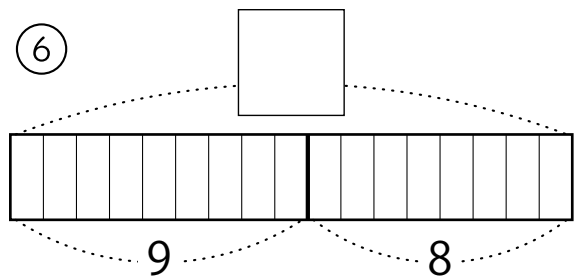
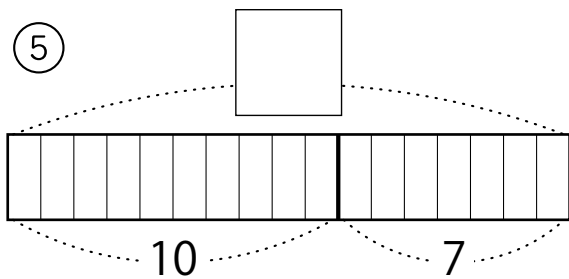
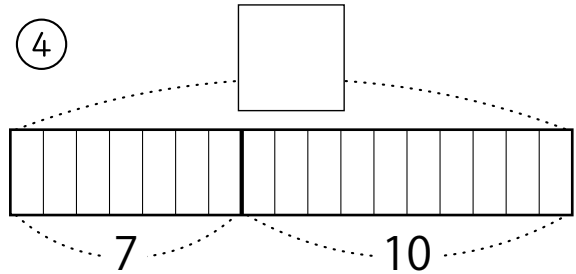
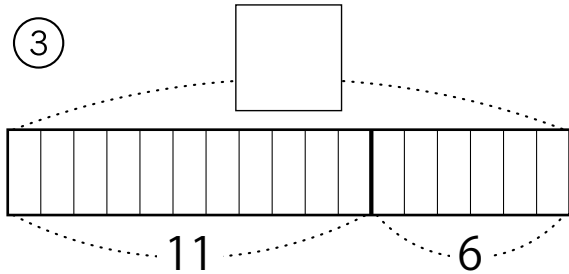
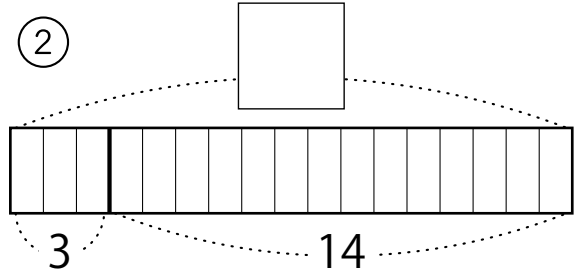
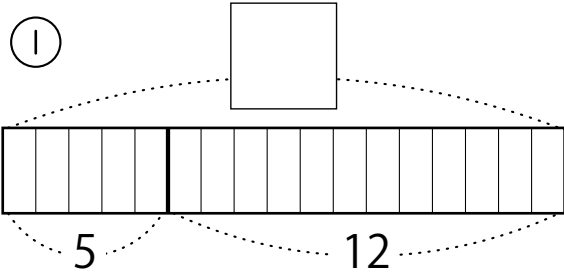

テープ図で かんがえる たしざん (15から20まで)
あいている の中に 2つのかずをあわせたかずを書こう

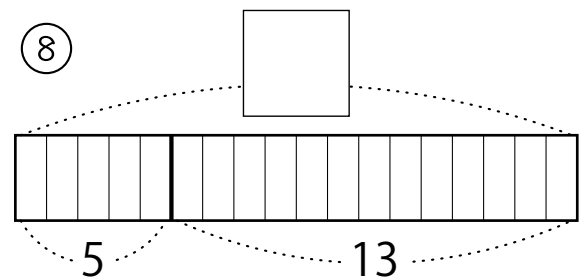
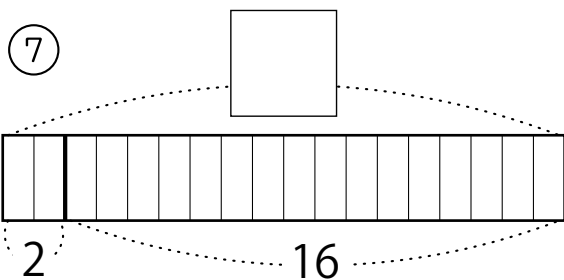
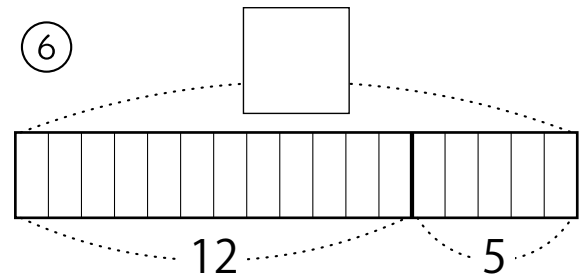
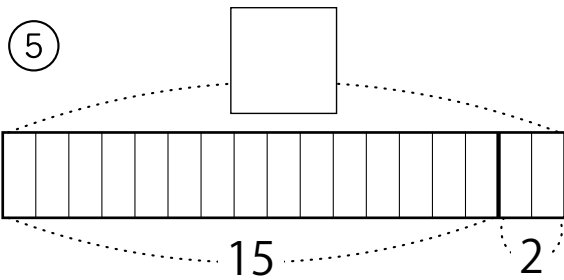
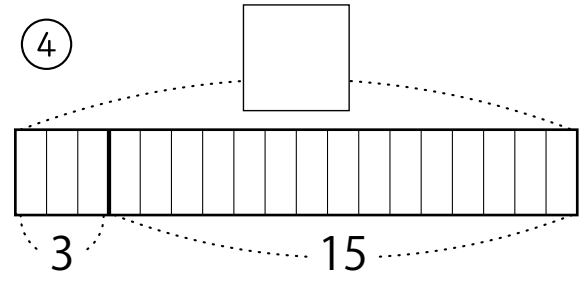
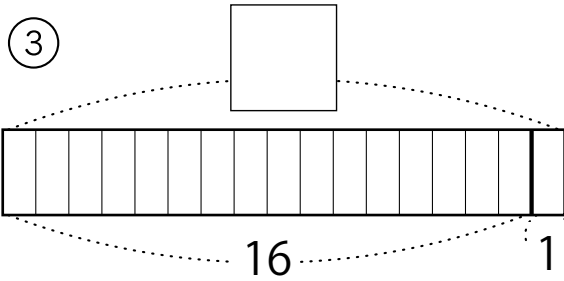
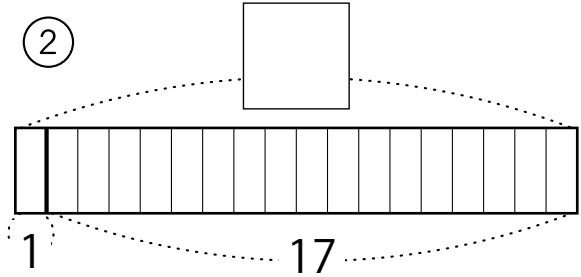
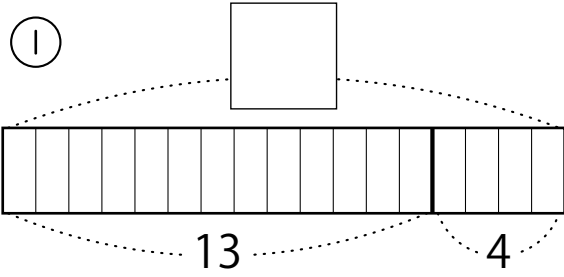

テープ図でかんがえる たしざん (15から20まで)
あいている□の中に2つのかずをあわせたかずを書こう

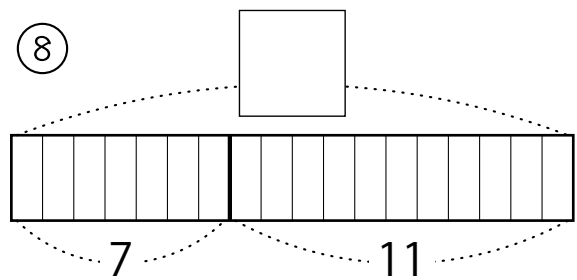
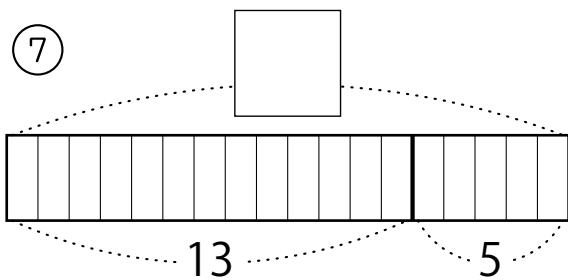
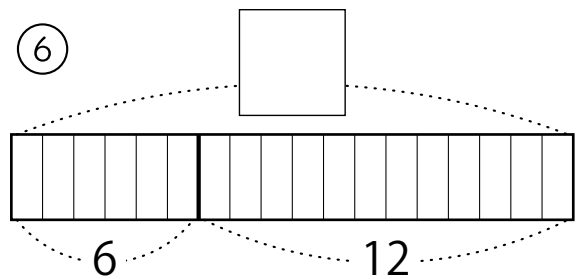
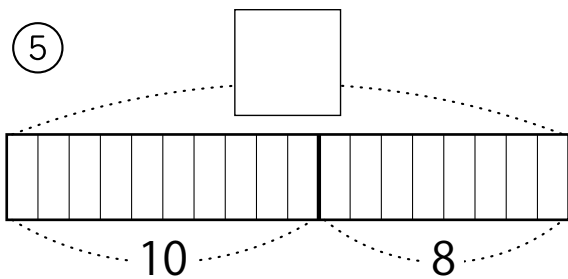
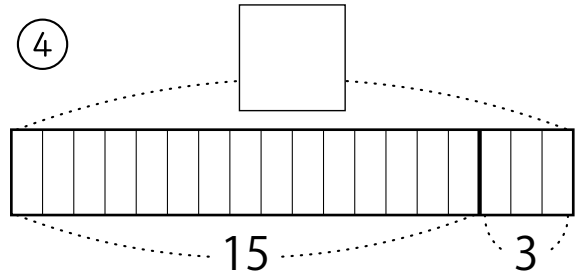
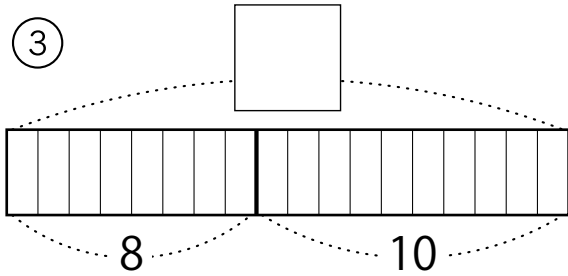
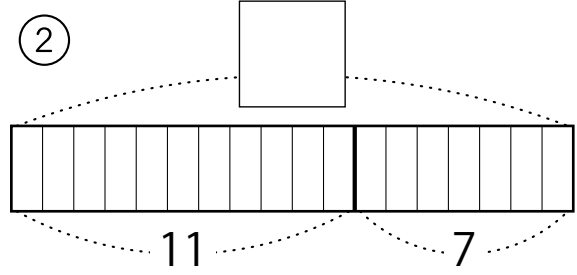
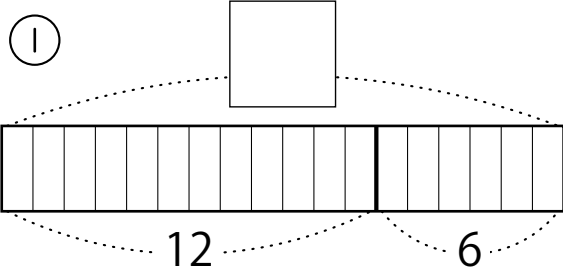

テープ図でかんがえる たしざん (15から20まで)
あいている□の中に2つのかずをあわせたかずを書こう

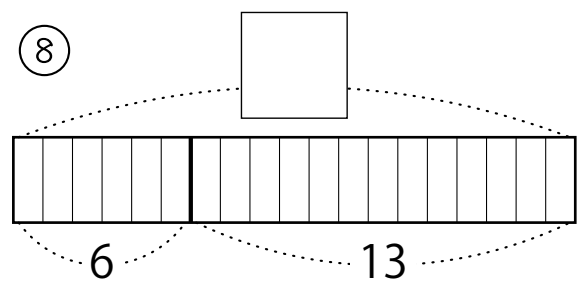
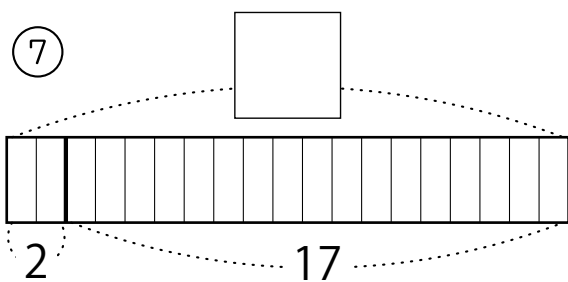
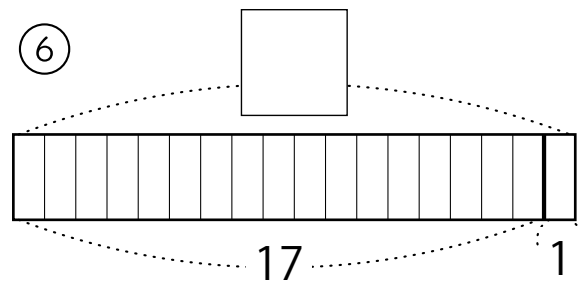
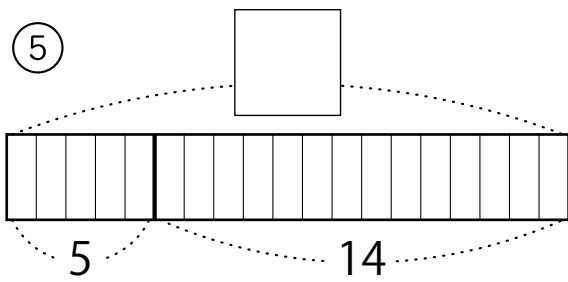
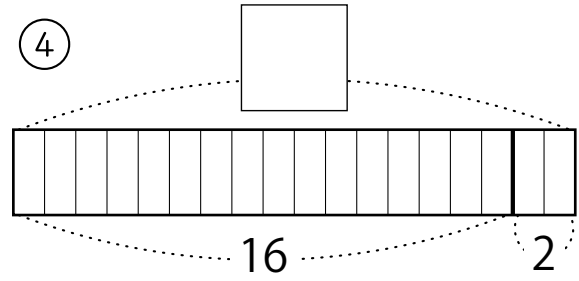
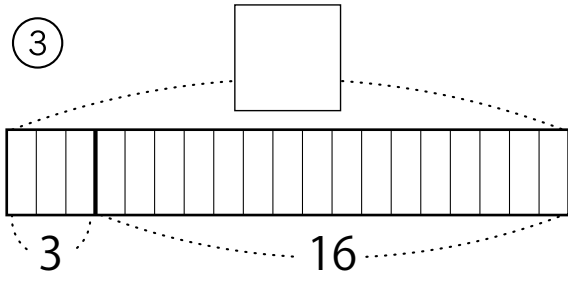
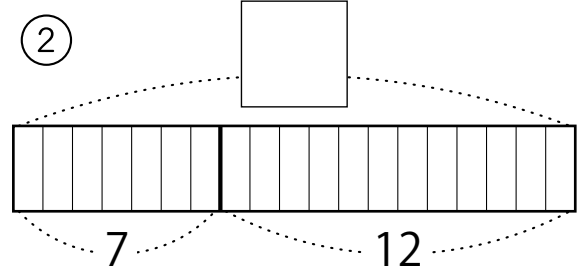
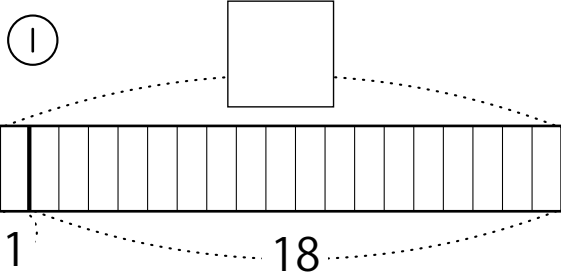

テープ図でかんがえる たしざん (15から20まで)
あいている□の中に2つのかずをあわせたかずを書こう

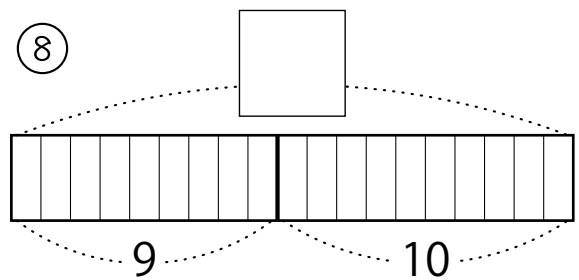
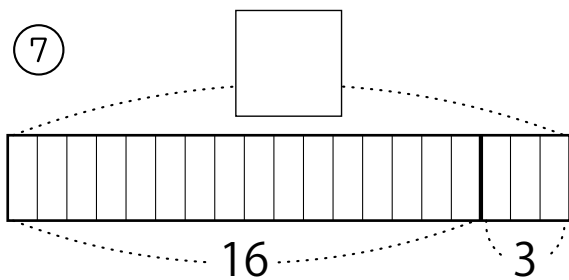
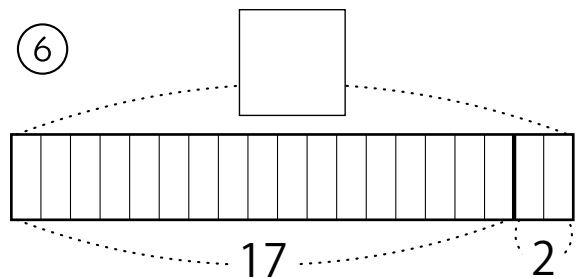
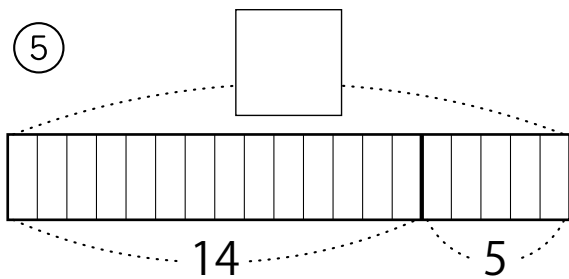
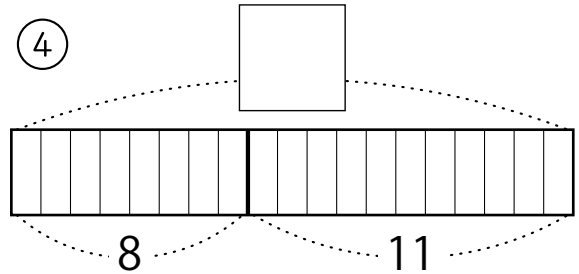
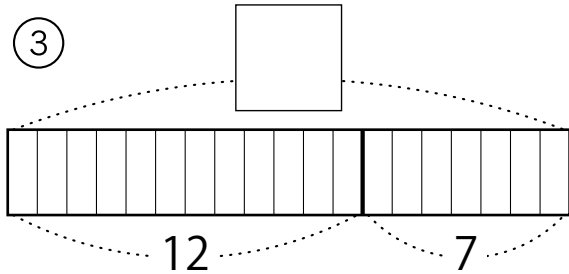
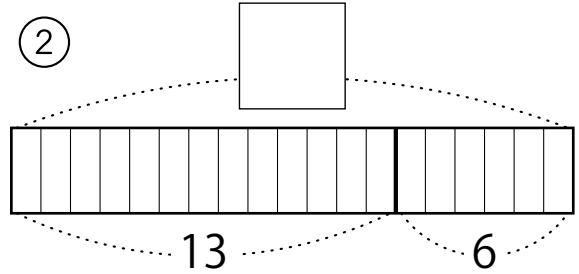
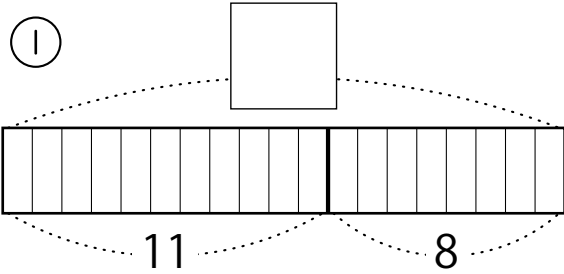

テープ図で かんがえる たしざん (15から20まで)
あいている の中に 2つのかずをあわせたかずを書こう

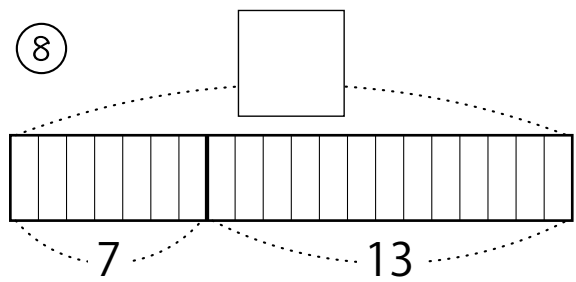
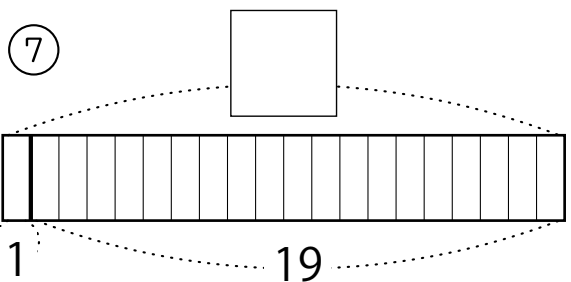
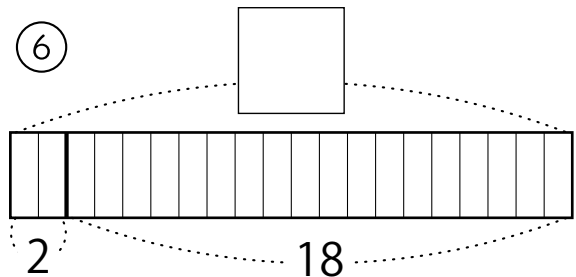
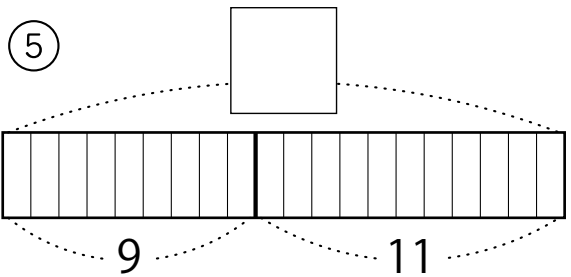
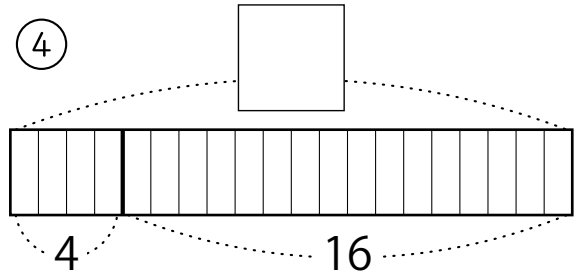
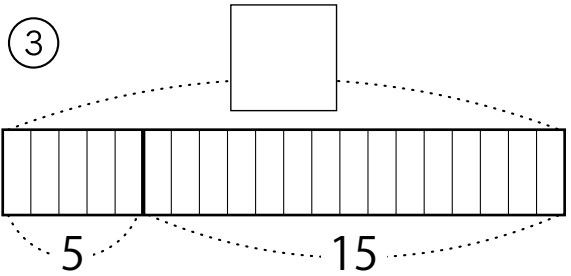
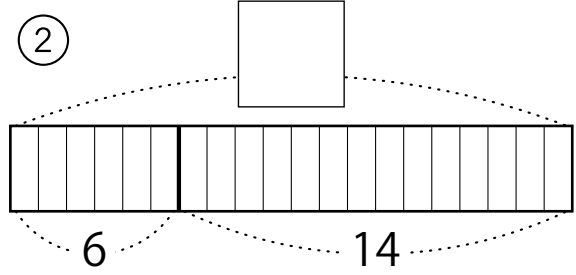
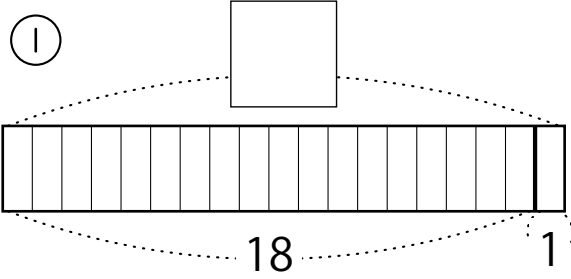

テープ図
たし算
足し算

テープ図で かんがえる たしざん (15から20まで)
あいている の中に 2つのかずをあわせたかずを書こう

